

HUMMINGBIRD 01
3 BEDROOM

1888 SQ FT

1788 SQ FT
INTERIOR +
100 SQ FT
BALCONY

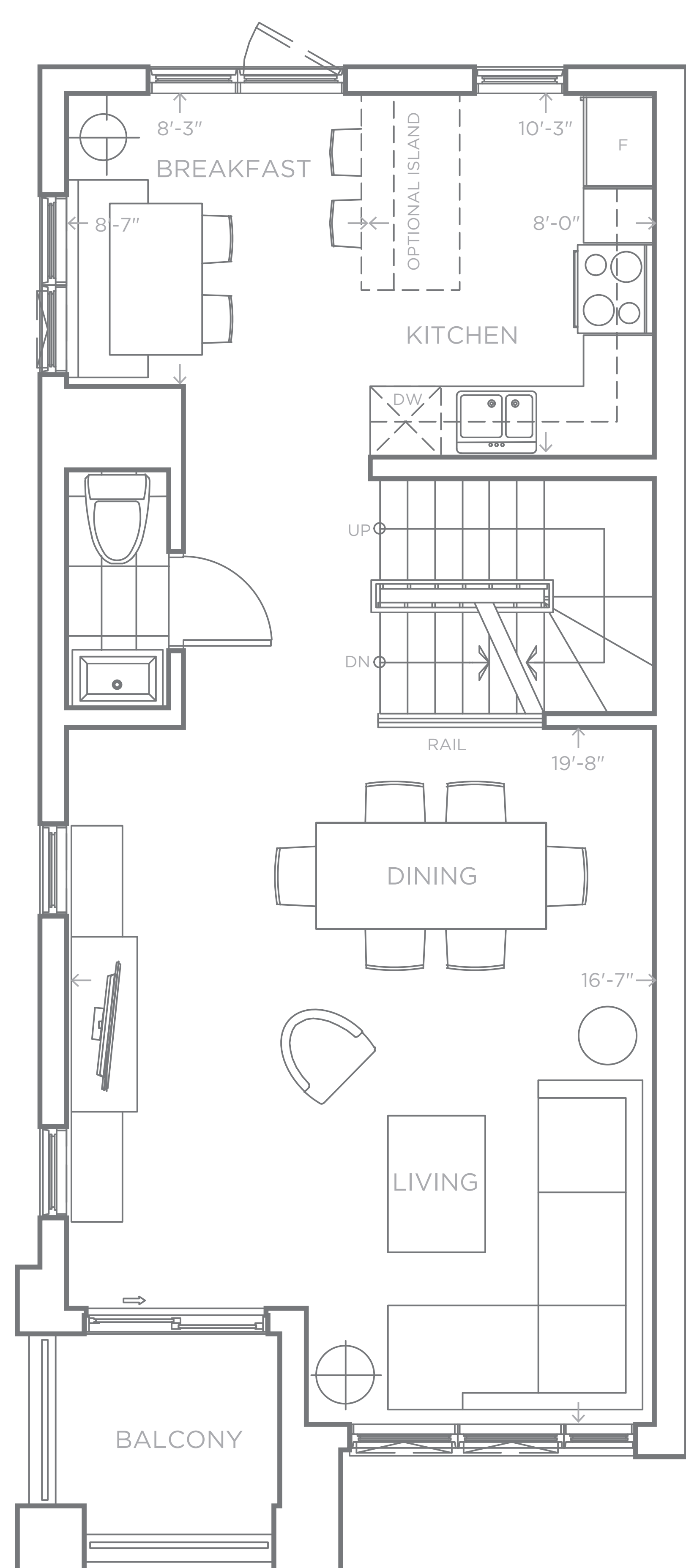

SECOND FLOOR

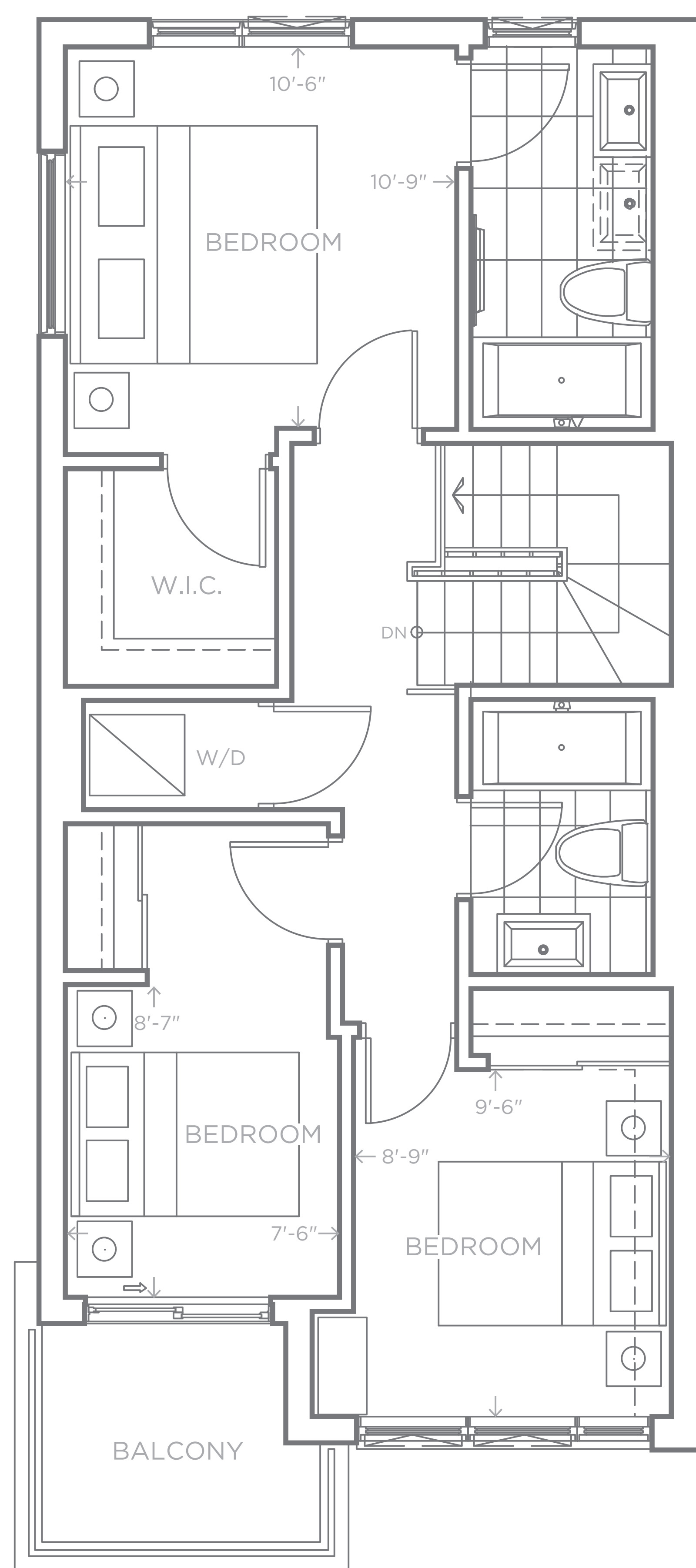

THIRD FLOOR

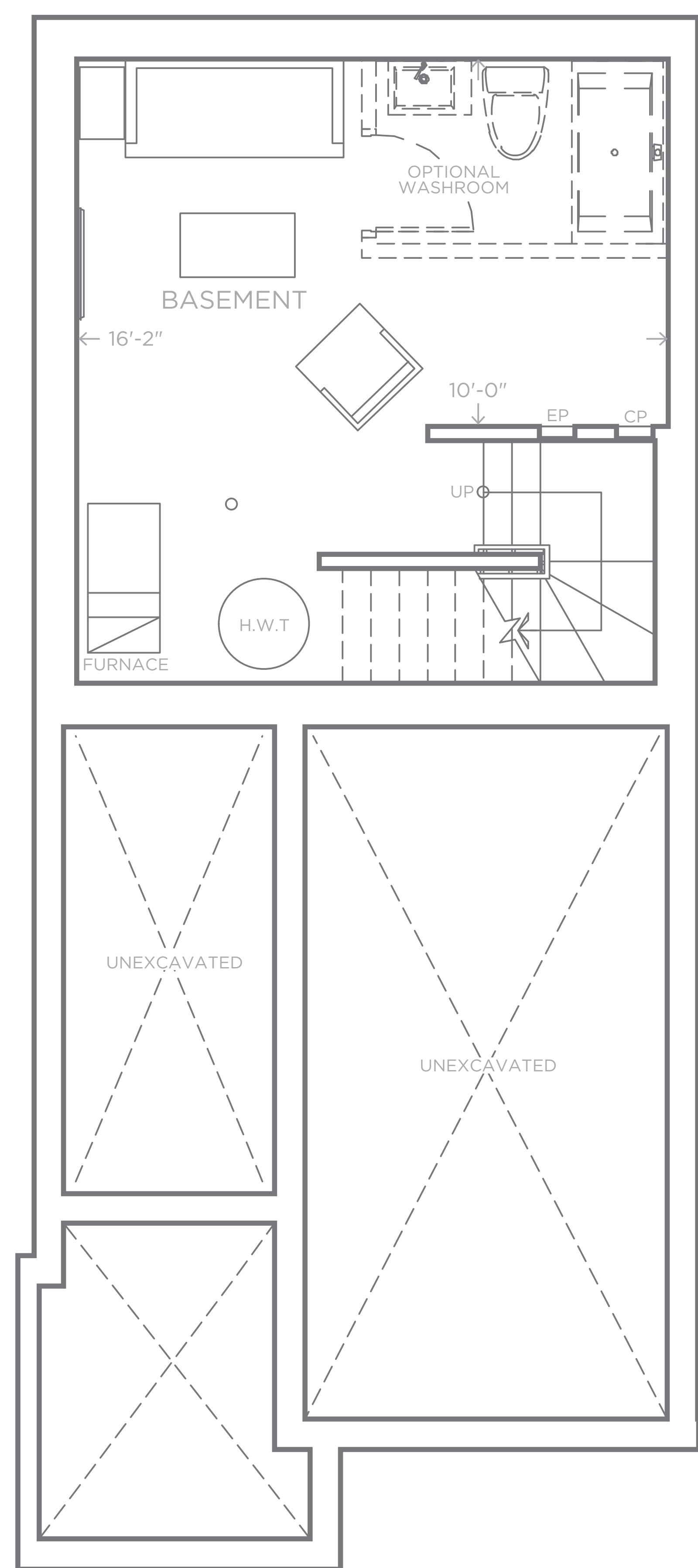

BASEMENT

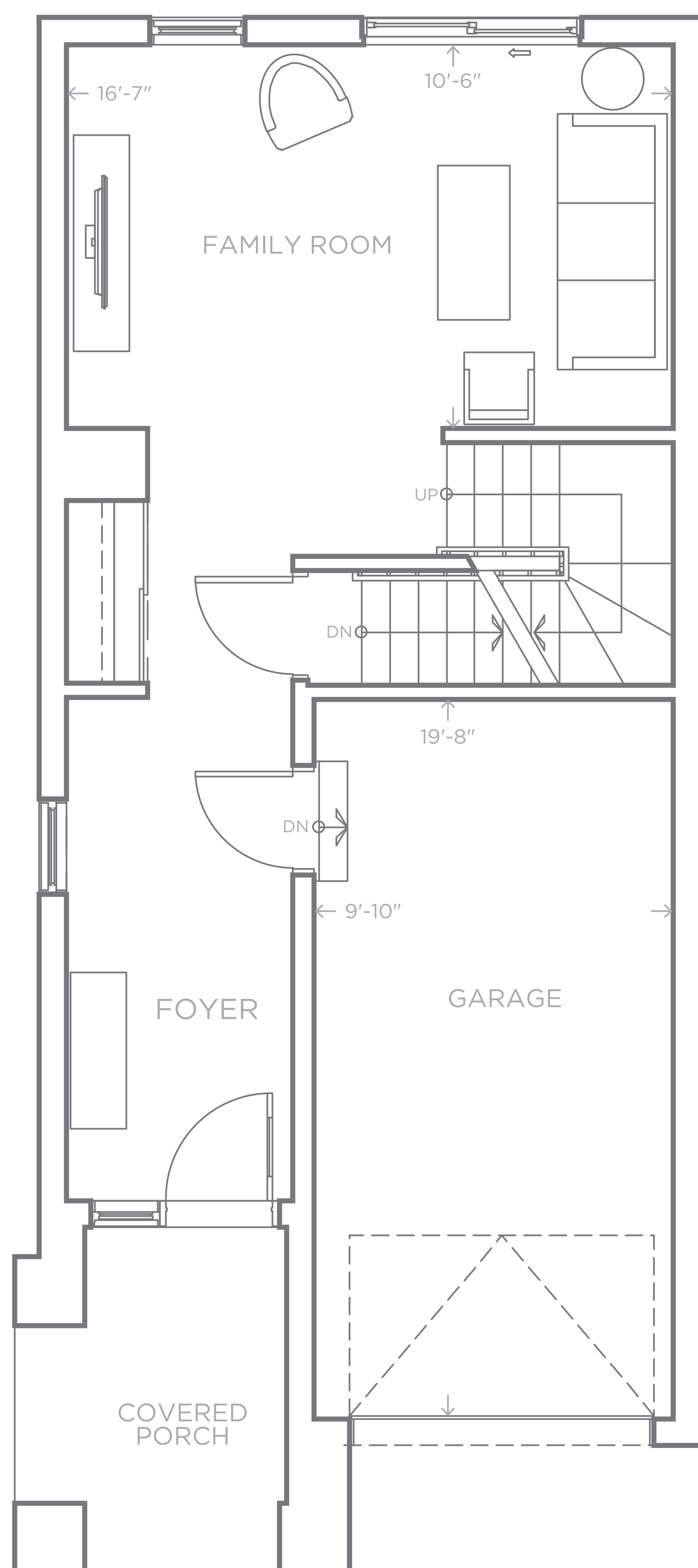

GROUND FLOOR

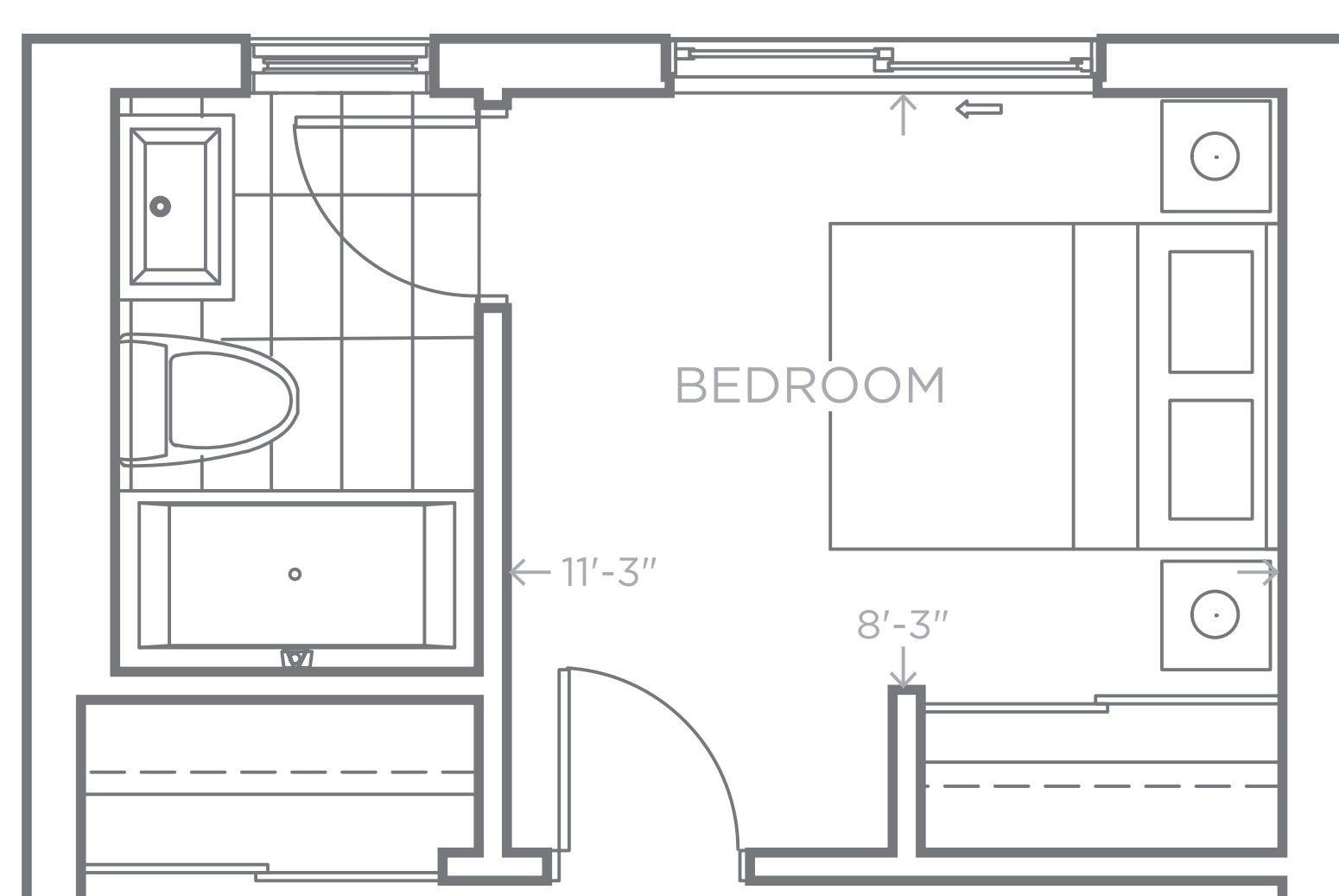

*OPTIONAL GROUND FLOOR
4TH BEDROOM + ENSUITE

Exterior, windows, colours, grading, landscaping, garage and entrance doors may vary from the renderings. Furniture is displayed for illustration purposes only and does not necessarily reflect the electrical plan for the unit. Units are sold unfurnished. Materials, sizes and specifications are subject to change without notice. Orientation of suite may be reversed and purchaser agrees to accept same. Exterior colours, grading, landscaping, garage and entrance doors may vary from the renderings. All Schedule Y's attached to the legal agreement of purchase and sale supersede artist's renderings. The dimensions shown on this plan are approximate only. Actual useable floor space within the unit may vary from any stated floor areas or dimensions on this plan. For more information on the method used for calculating the floor area of any unit, reference should be made to Builder Bulletin No. 22 published by Tarion, E. & O.E. June 2020.

CARDINAL OI
3 BEDROOM

1888 SQ FT

1788 SQ FT
INTERIOR +
100 SQ FT
BALCONY

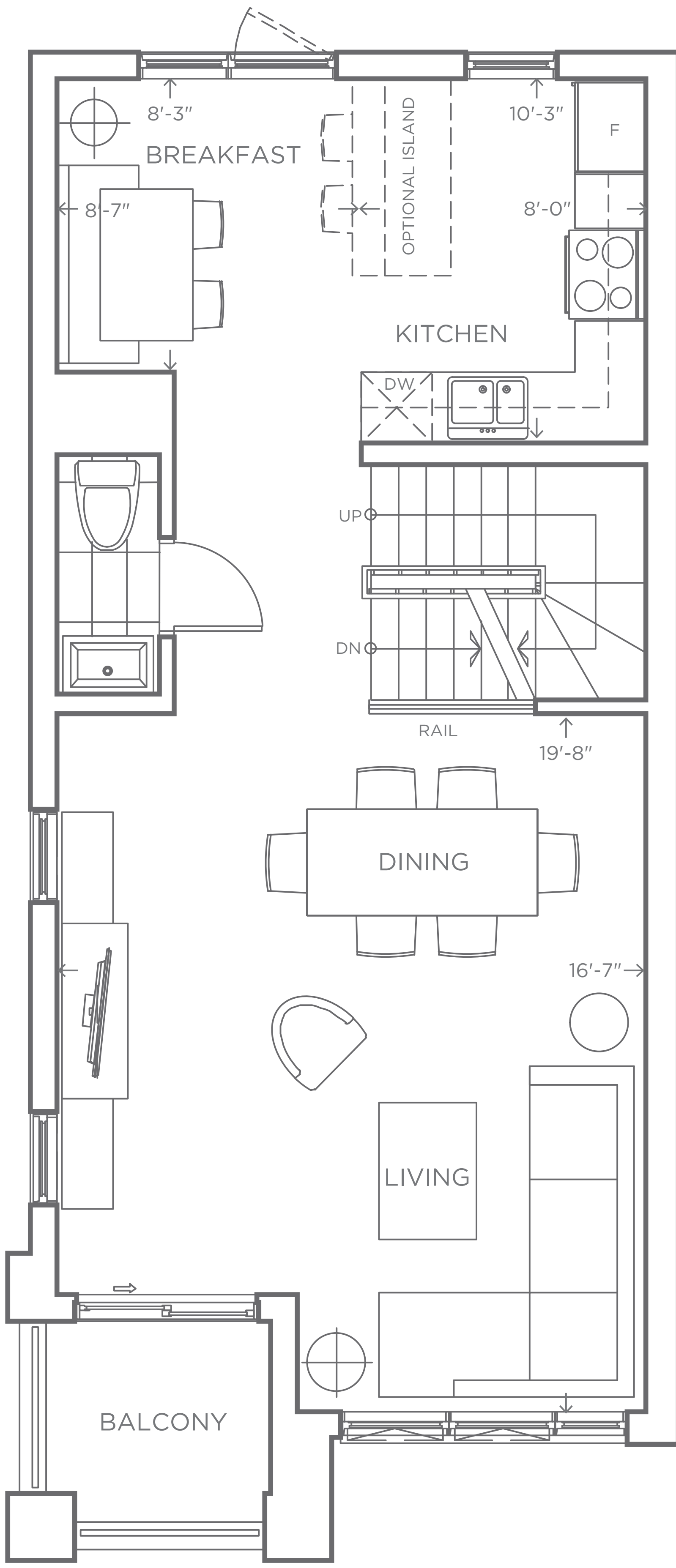

SECOND FLOOR

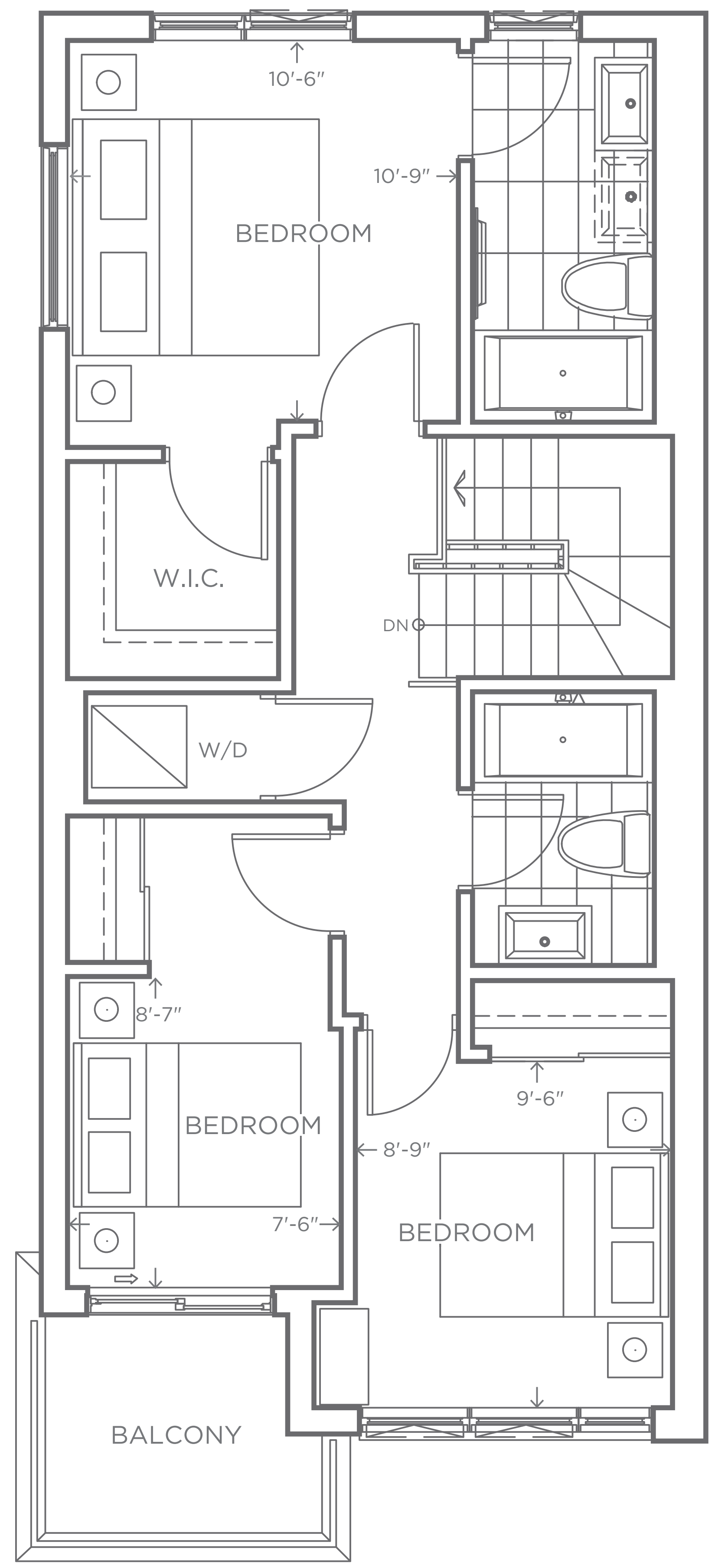

THIRD FLOOR

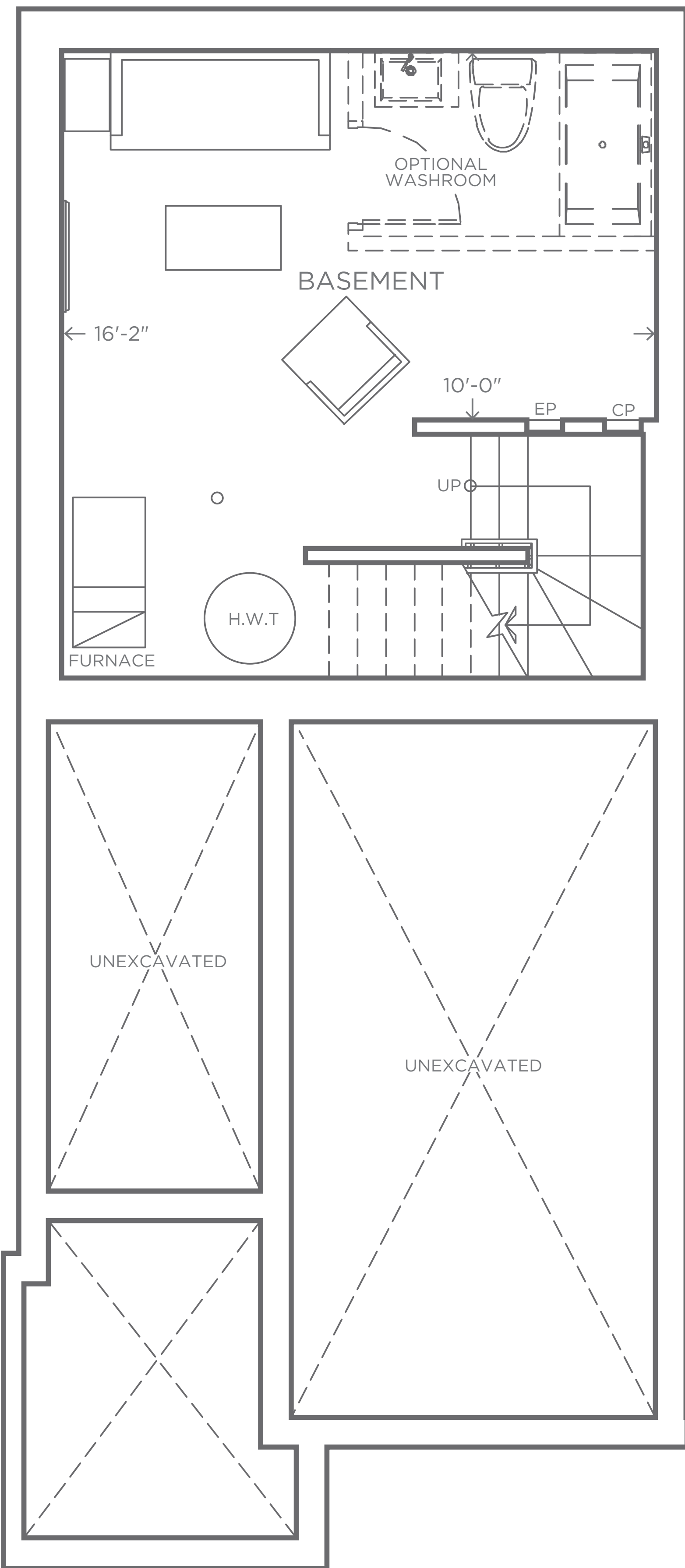

BASEMENT

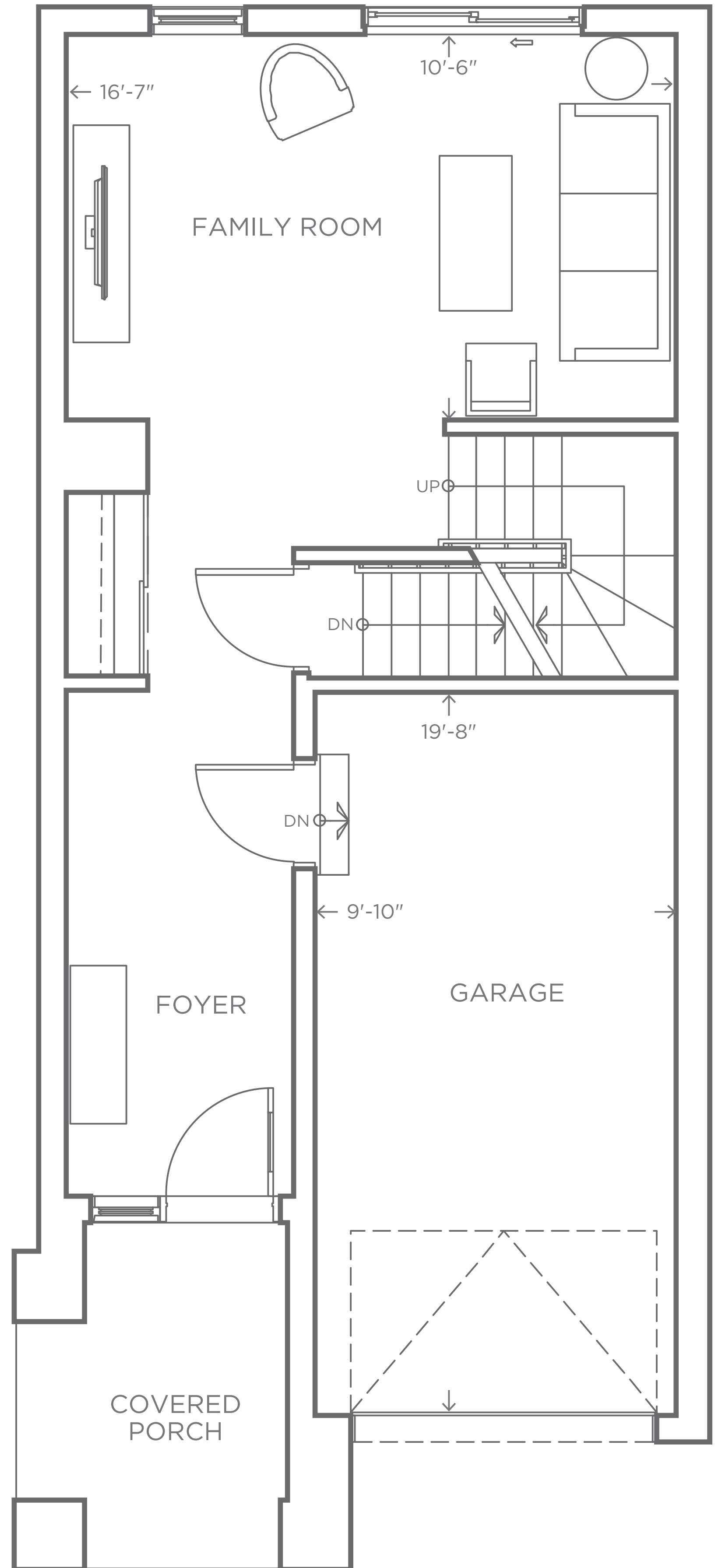

GROUND FLOOR

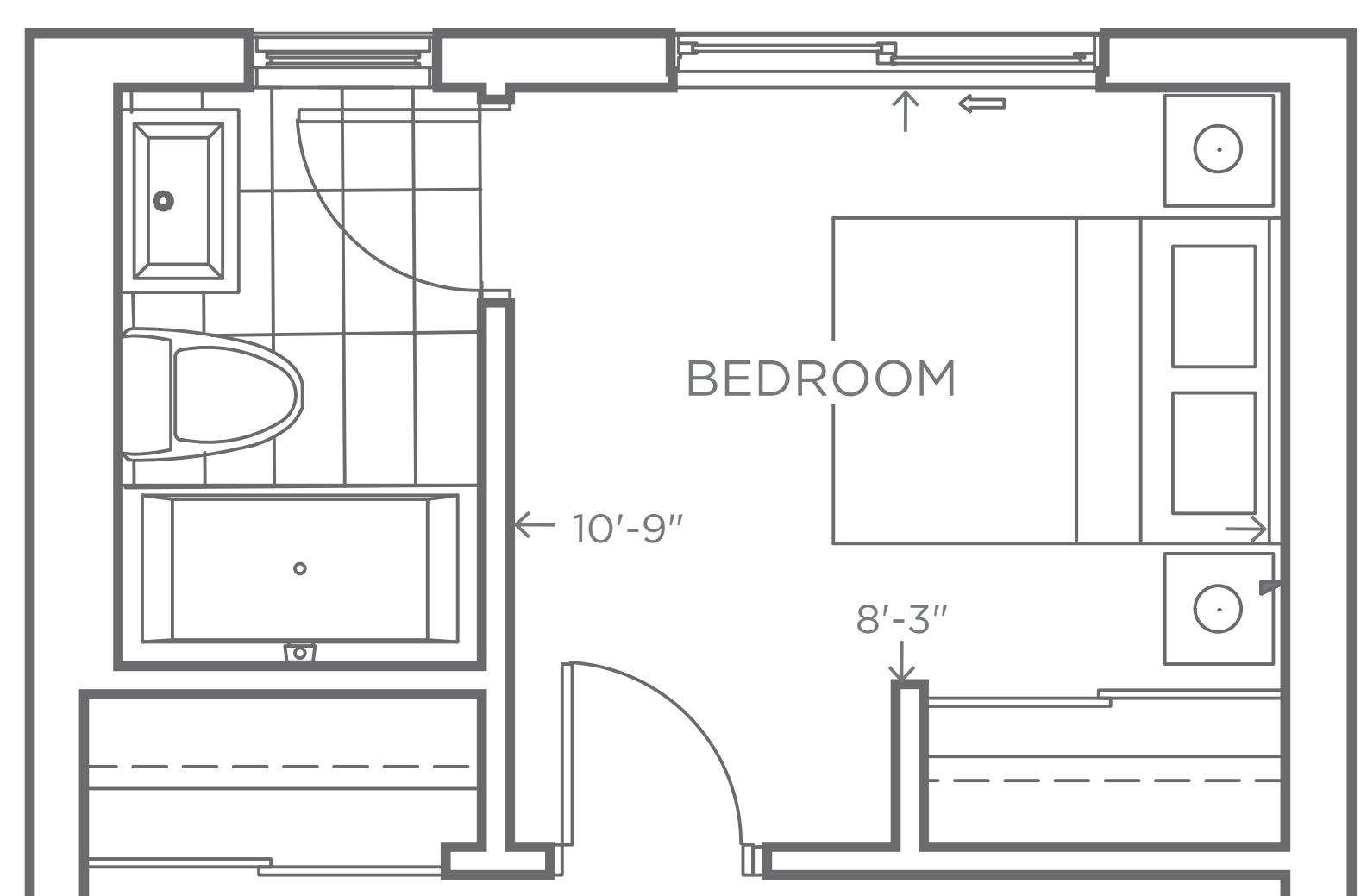

*OPTIONAL GROUND FLOOR
4TH BEDROOM + ENSUITE

SWAN O1
2 BEDROOM + STUDY

1664 SQ FT

1632 SQ FT
INTERIOR +
32 SQ FT
BALCONY

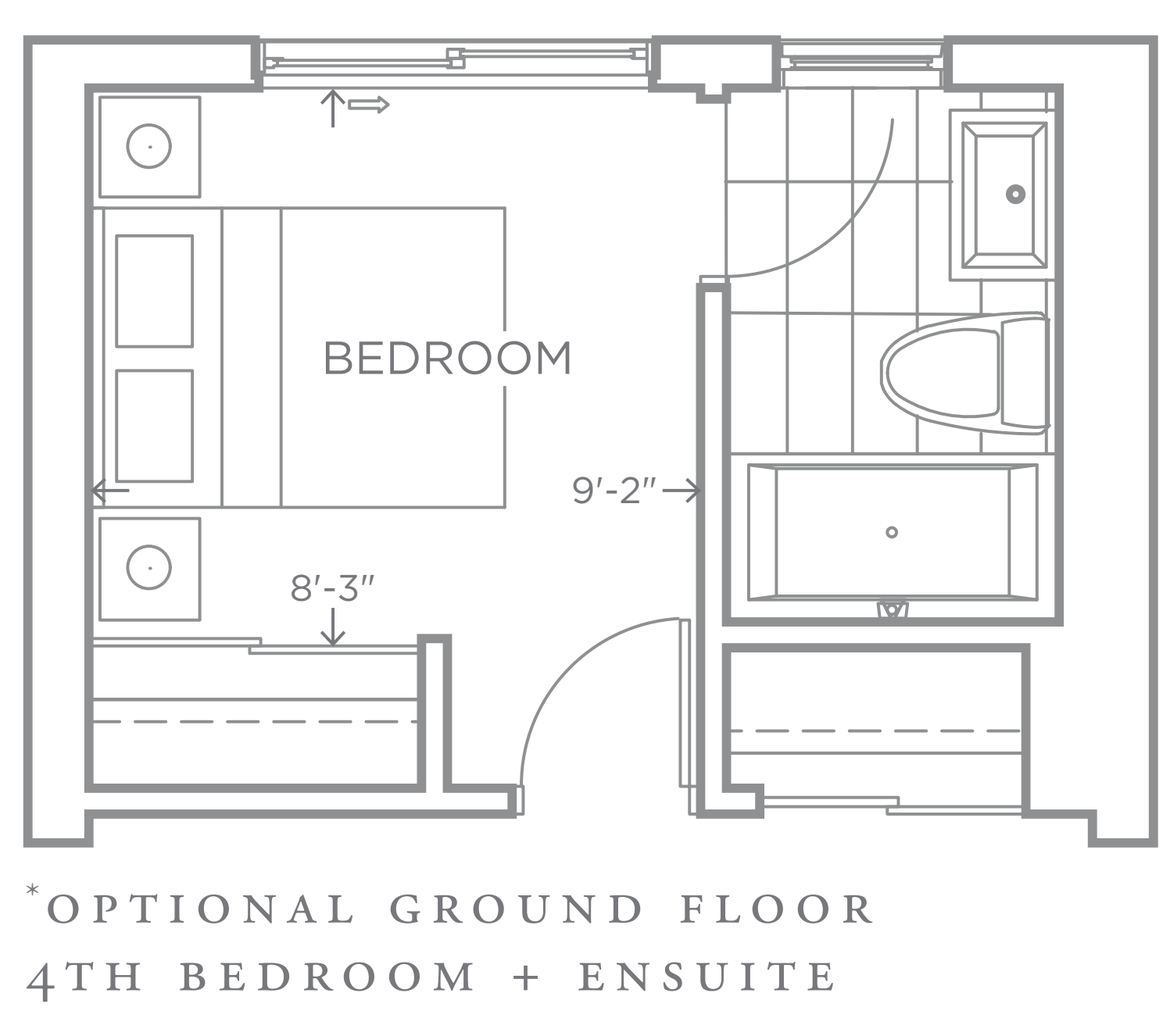
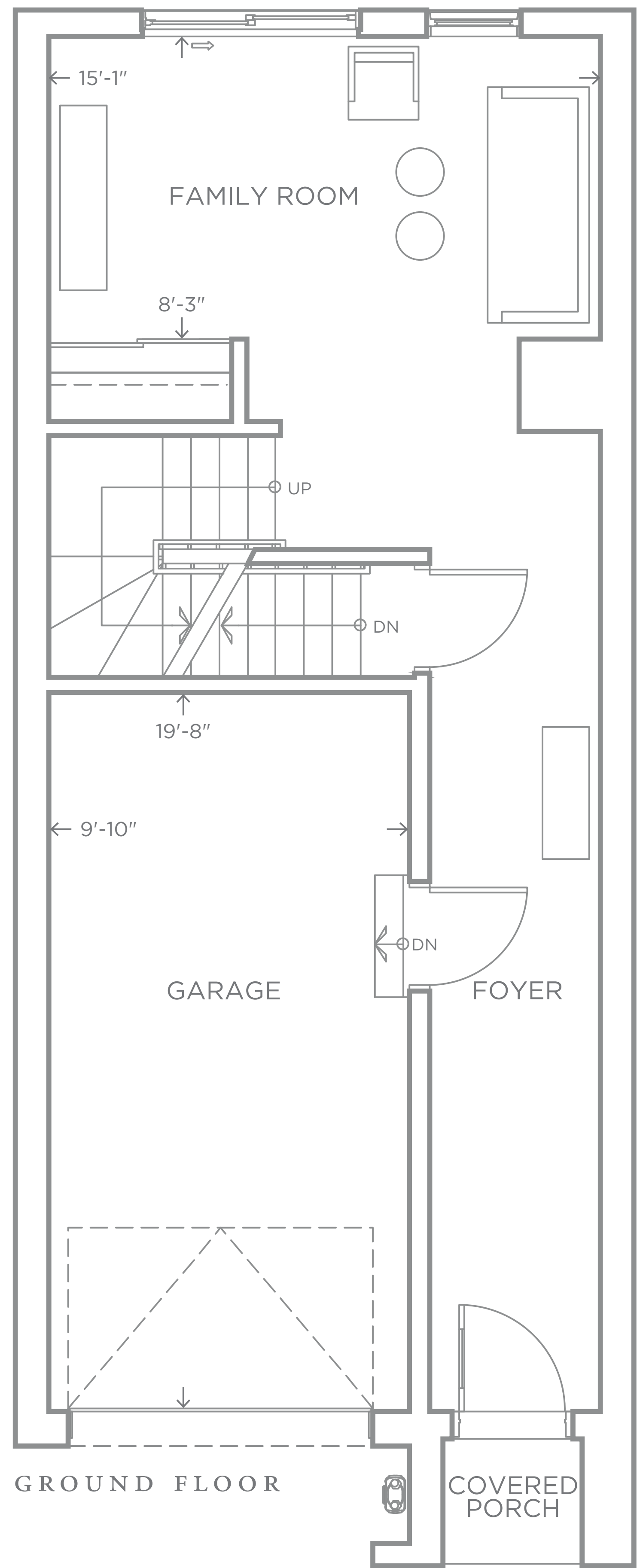
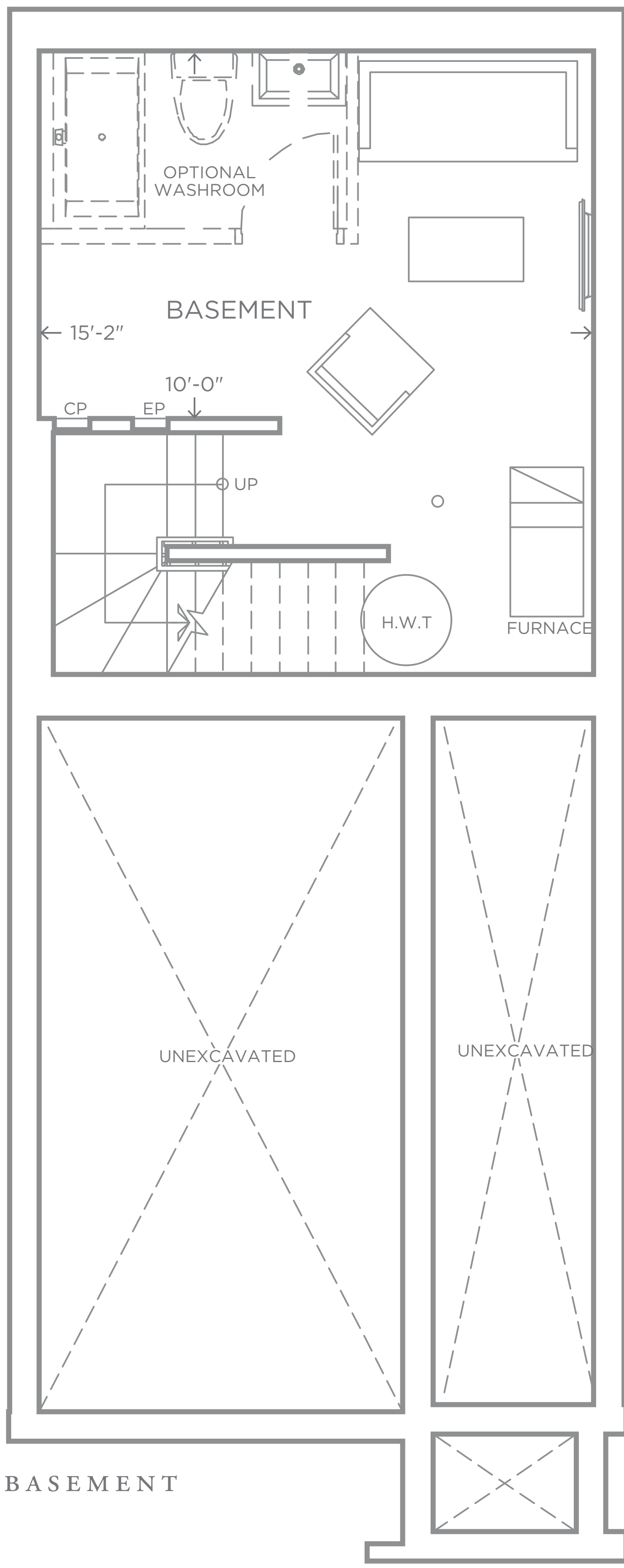
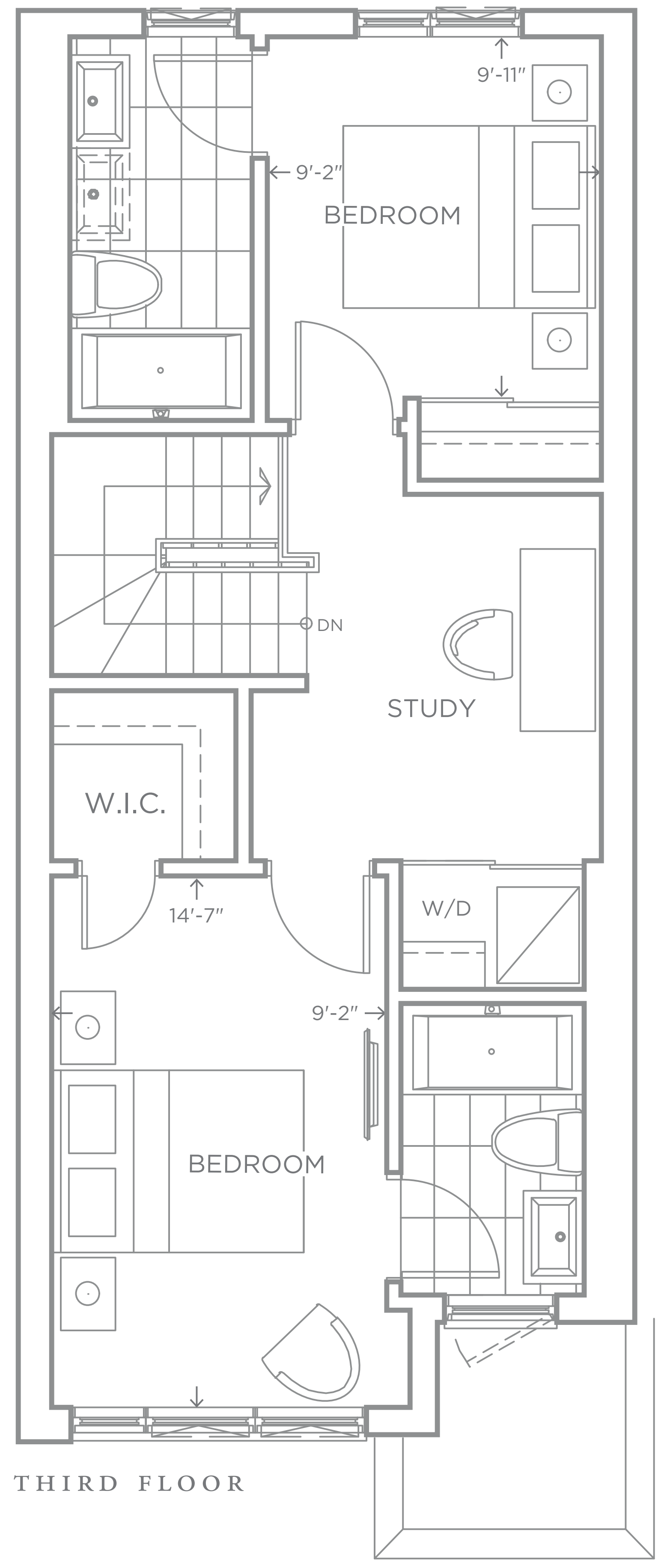
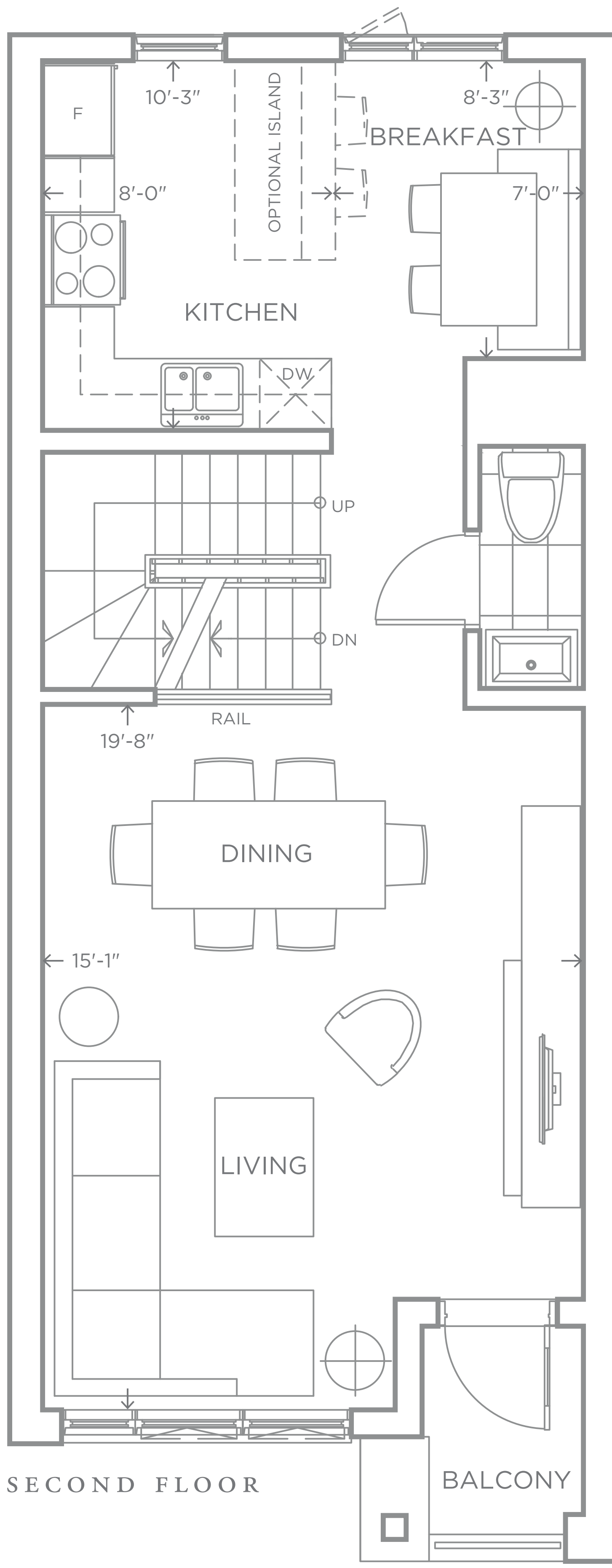

Exterior, windows, colours, grading, landscaping, garage and entrance doors may vary from the renderings. Furniture is displayed for illustration purposes only and does not necessarily reflect the electrical plan for the unit. Units are sold unfurnished. Materials, sizes and specifications are subject to change without notice. Orientation of suite may be reversed and purchaser agrees to accept same. Exterior colours, grading, landscaping, garage and entrance doors may vary from the renderings. All Schedule Y's attached to the legal agreement of purchase and sale supersede artist's renderings. The dimensions shown on this plan are approximate only. Actual useable floor space within the unit may vary from any stated floor areas or dimensions on this plan. For more information on the method used for calculating the floor area of any unit, reference should be made to Builder Bulletin No. 22 published by Tarion, E. & O.E. June 2020.

KINGFISHER OI
2 BEDROOM + STUDY

1664 SQ FT

1632 SQ FT
 INTERIOR +
 32 SQ FT
 BALCONY

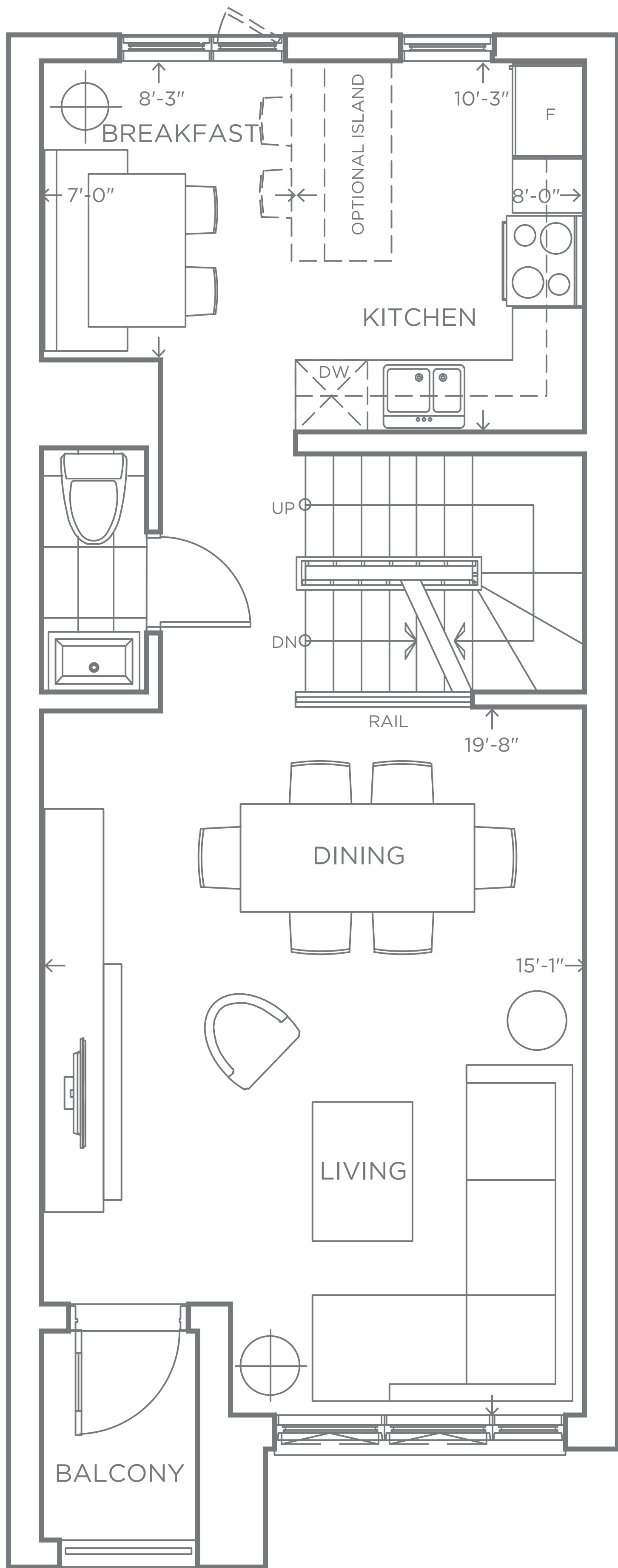

SECOND FLOOR

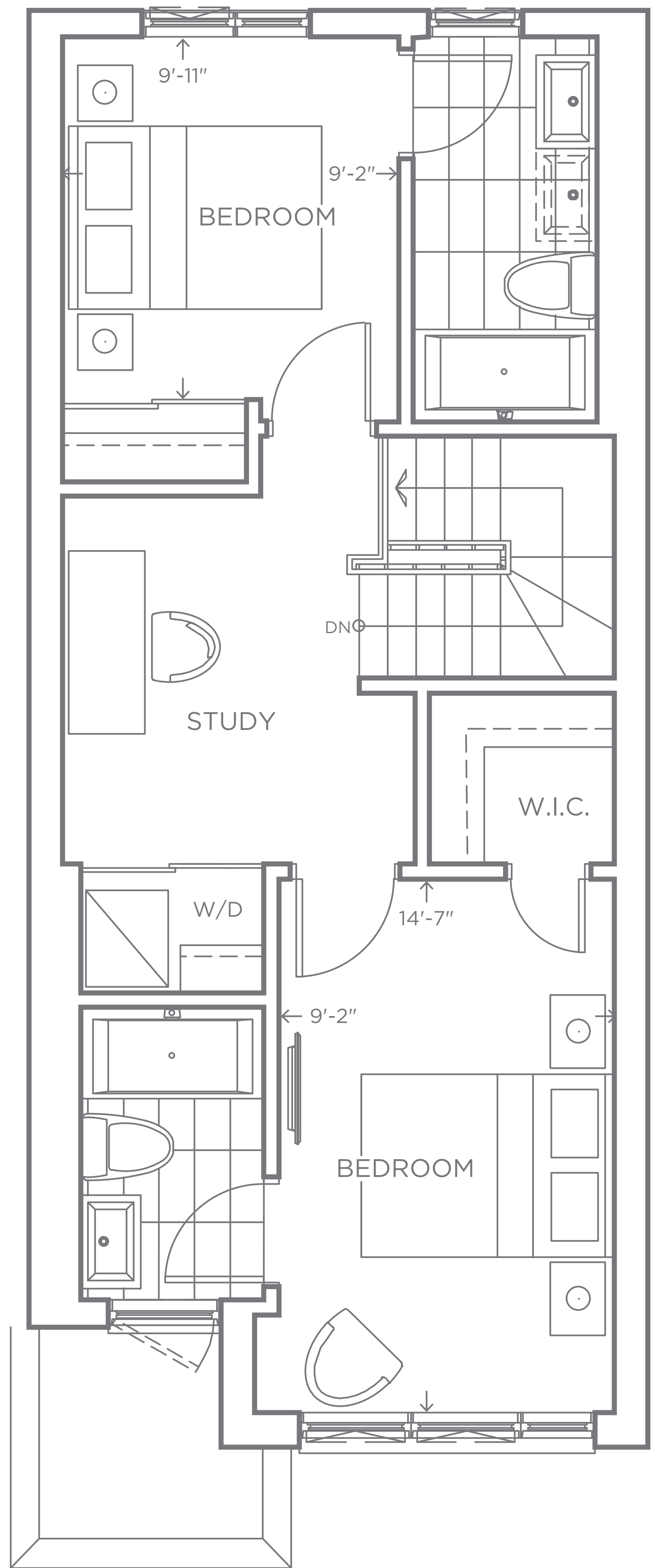

THIRD FLOOR

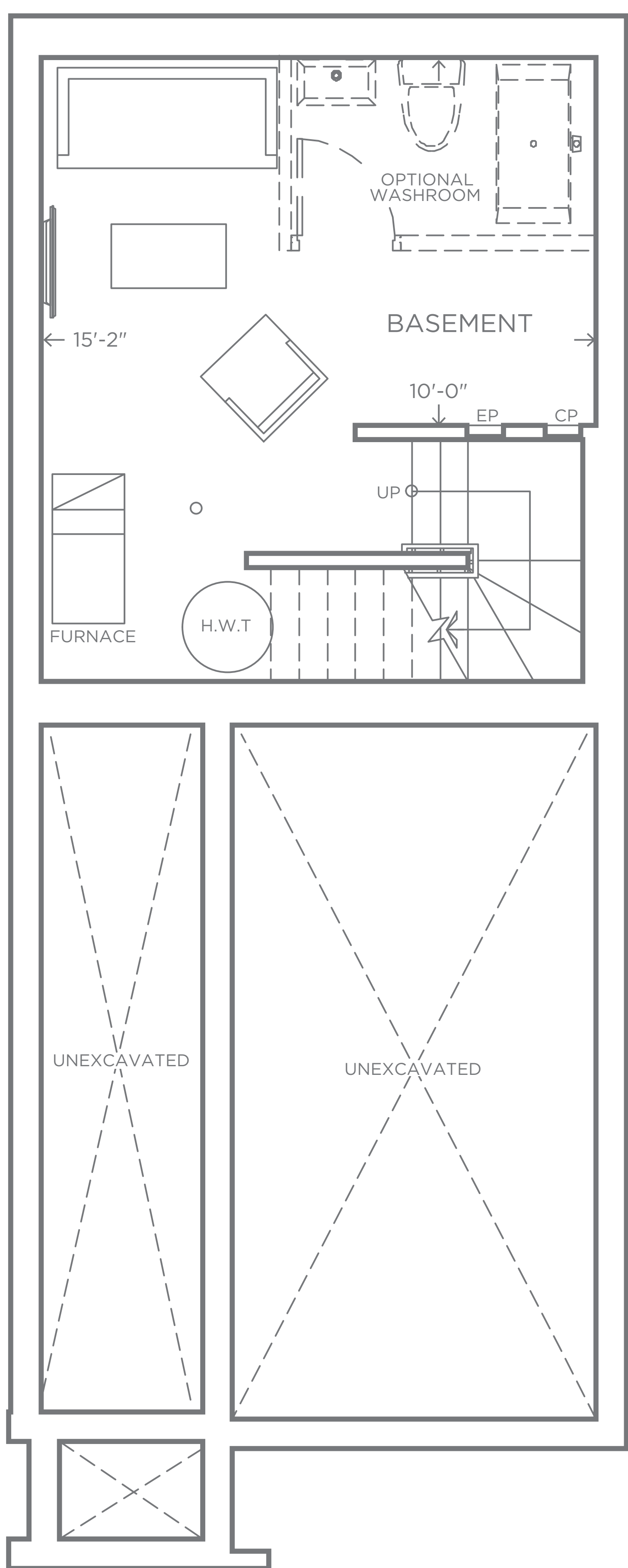

BASEMENT

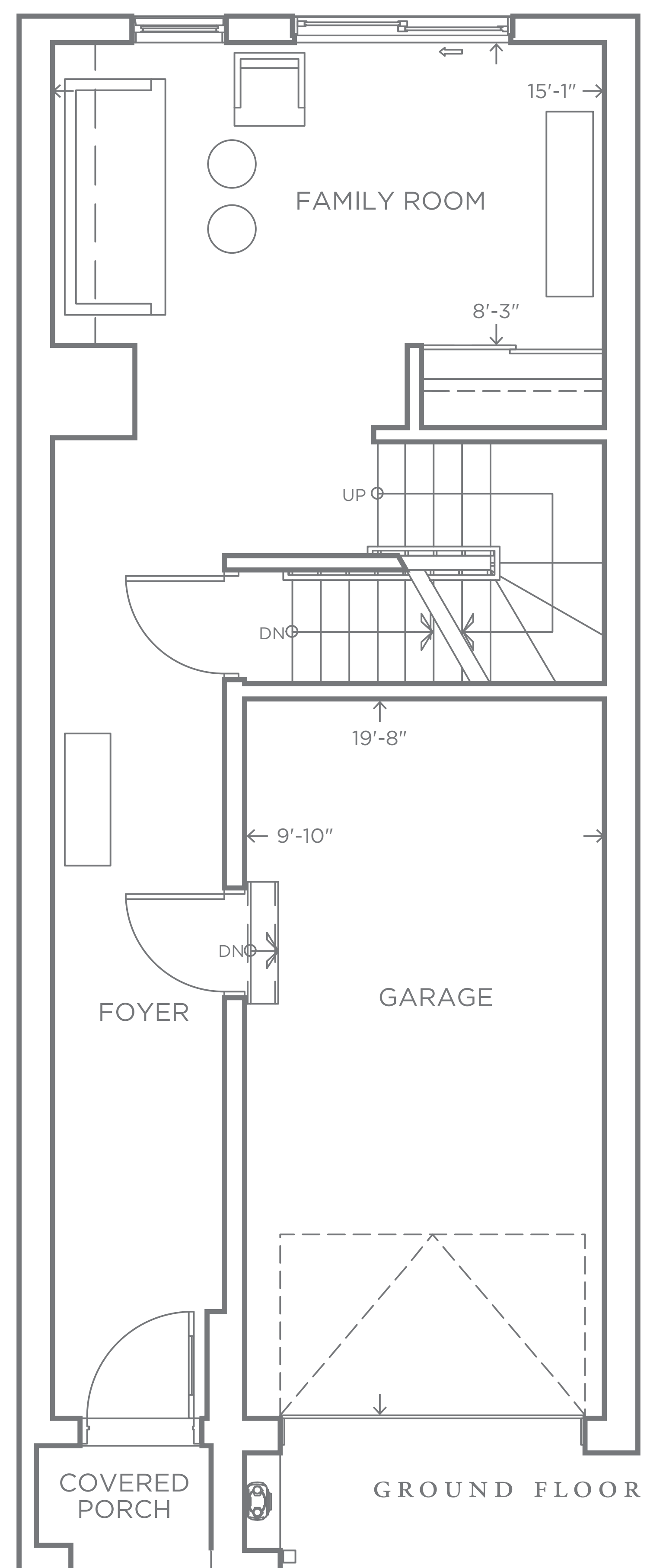

GROUND FLOOR

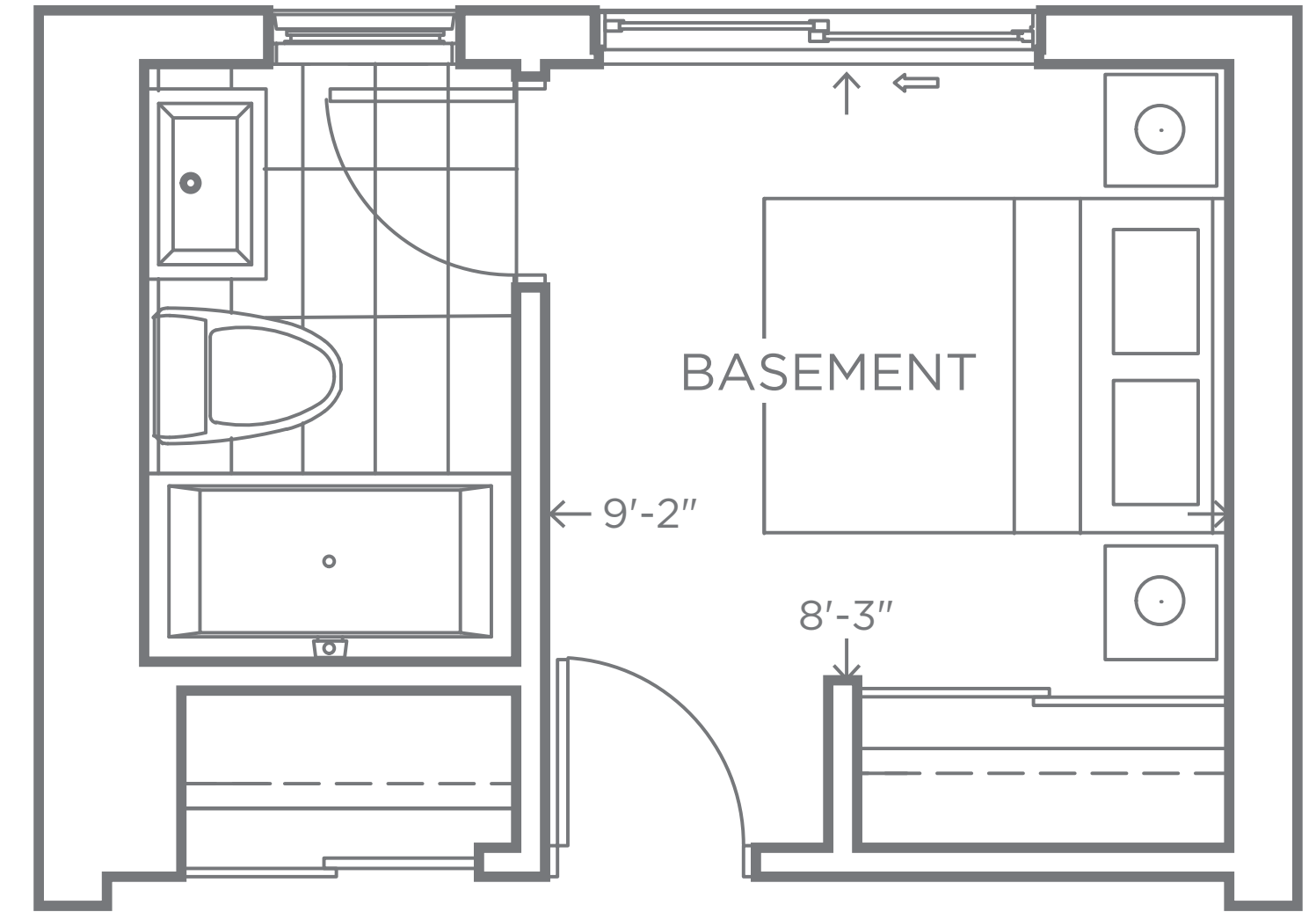

*OPTIONAL GROUND FLOOR
 4TH BEDROOM + ENSUITE

Exterior, windows, colours, grading, landscaping, garage and entrance doors may vary from the renderings. Furniture is displayed for illustration purposes only and does not necessarily reflect the electrical plan for the unit. Units are sold unfurnished. Materials, sizes and specifications are subject to change without notice. Orientation of suite may be reversed and purchaser agrees to accept same. Exterior colours, grading, landscaping, garage and entrance doors may vary from the renderings. All Schedule Y's attached to the legal agreement of purchase and sale supersede artist's renderings. The dimensions shown on this plan are approximate only. Actual useable floor space within the unit may vary from any stated floor areas or dimensions on this plan. For more information on the method used for calculating the floor area of any unit, reference should be made to Builder Bulletin No. 22 published by Tarion, E. & O.E. June 2020.

ROBIN OI
2 BEDROOM + STUDY

1664 SQ FT

1632 SQ FT
 INTERIOR +
 32 SQ FT
 BALCONY

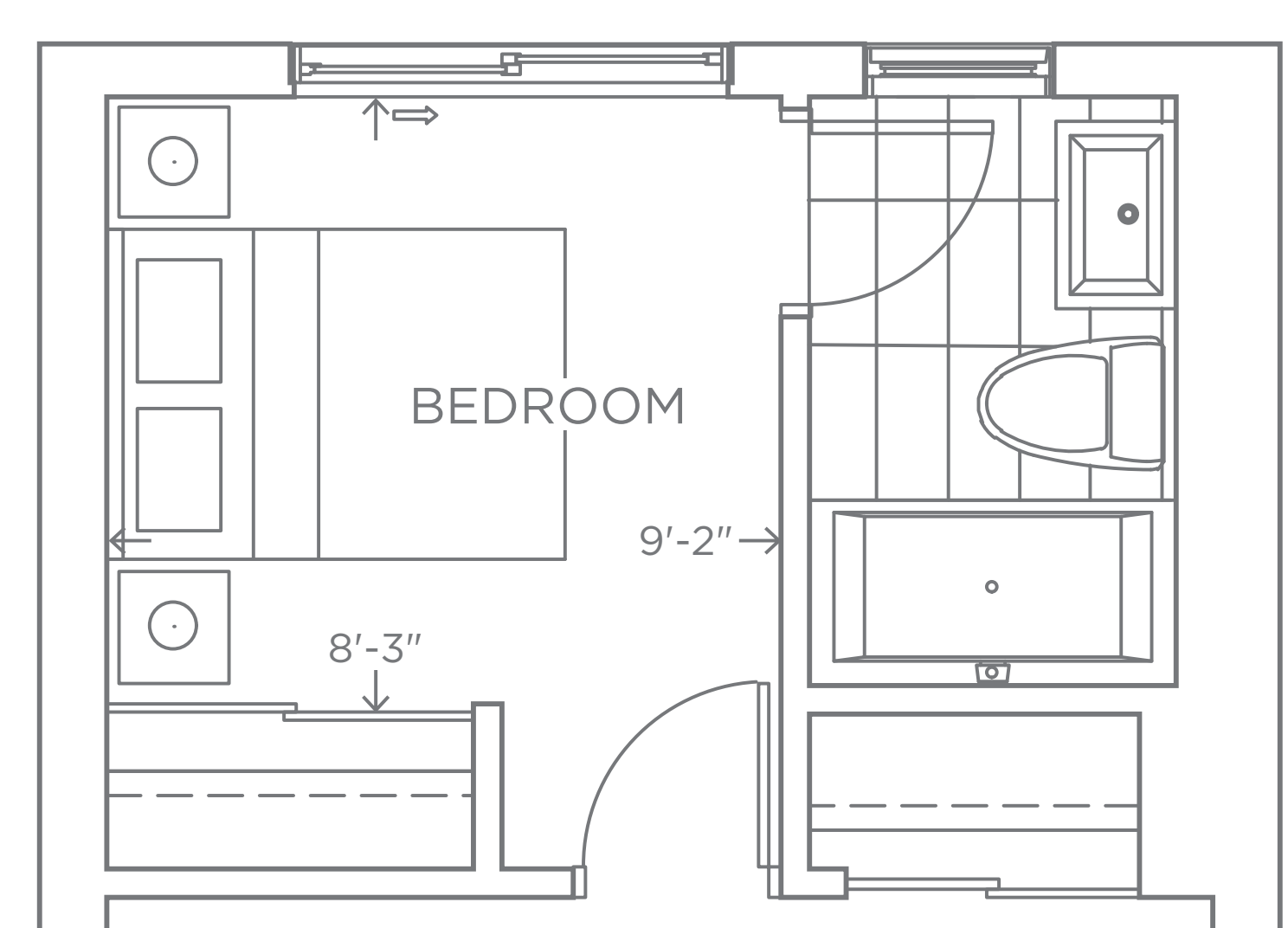
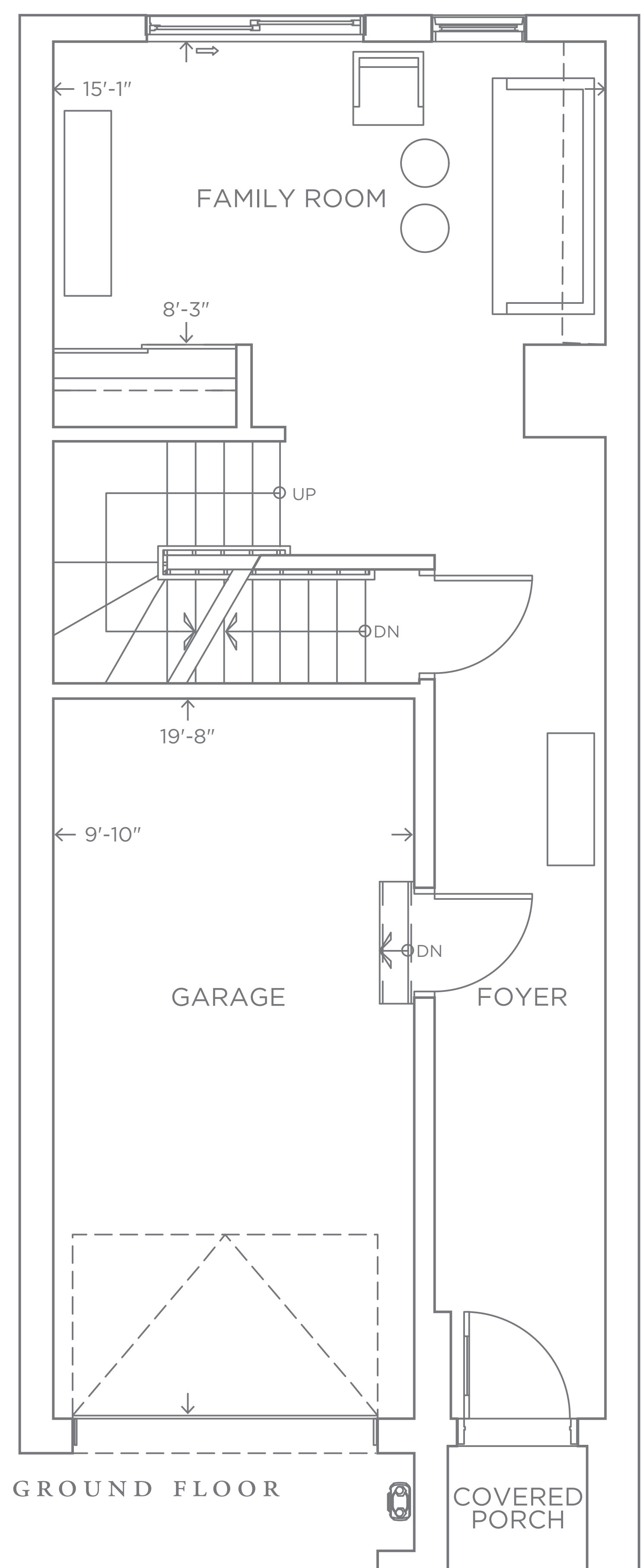
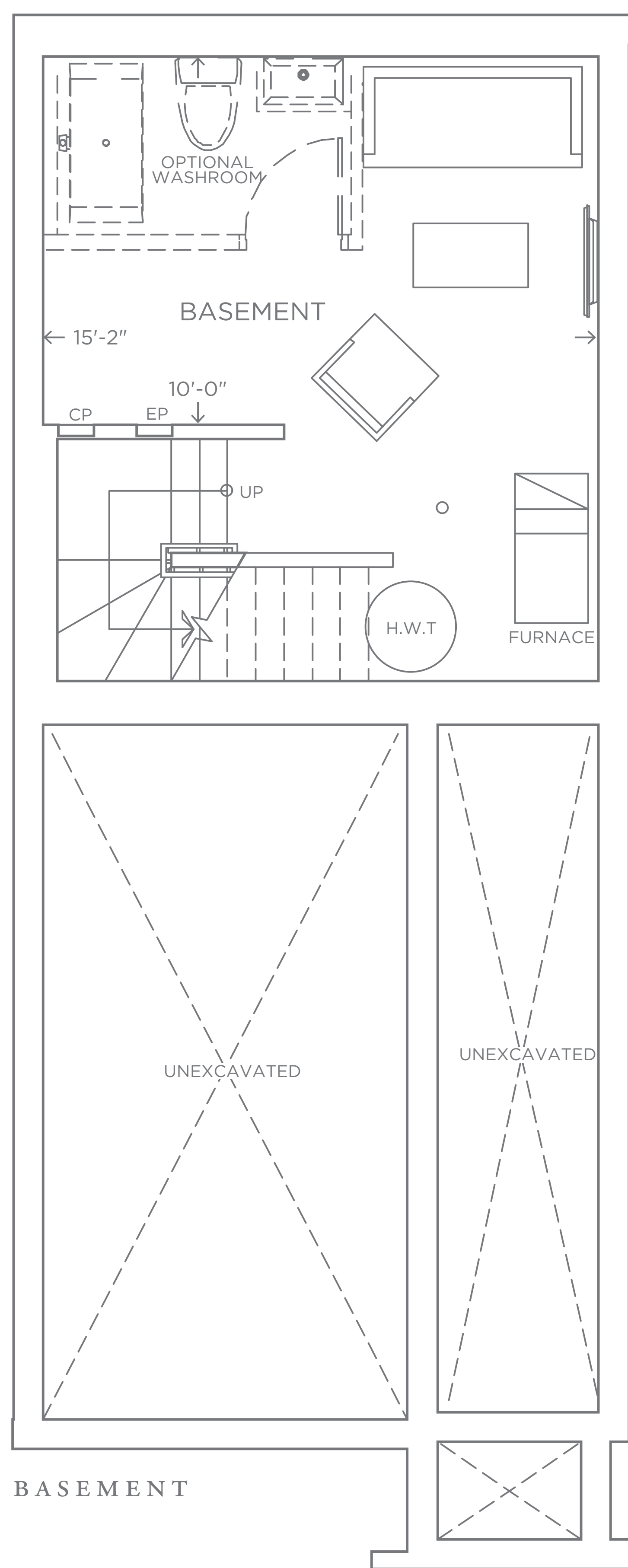
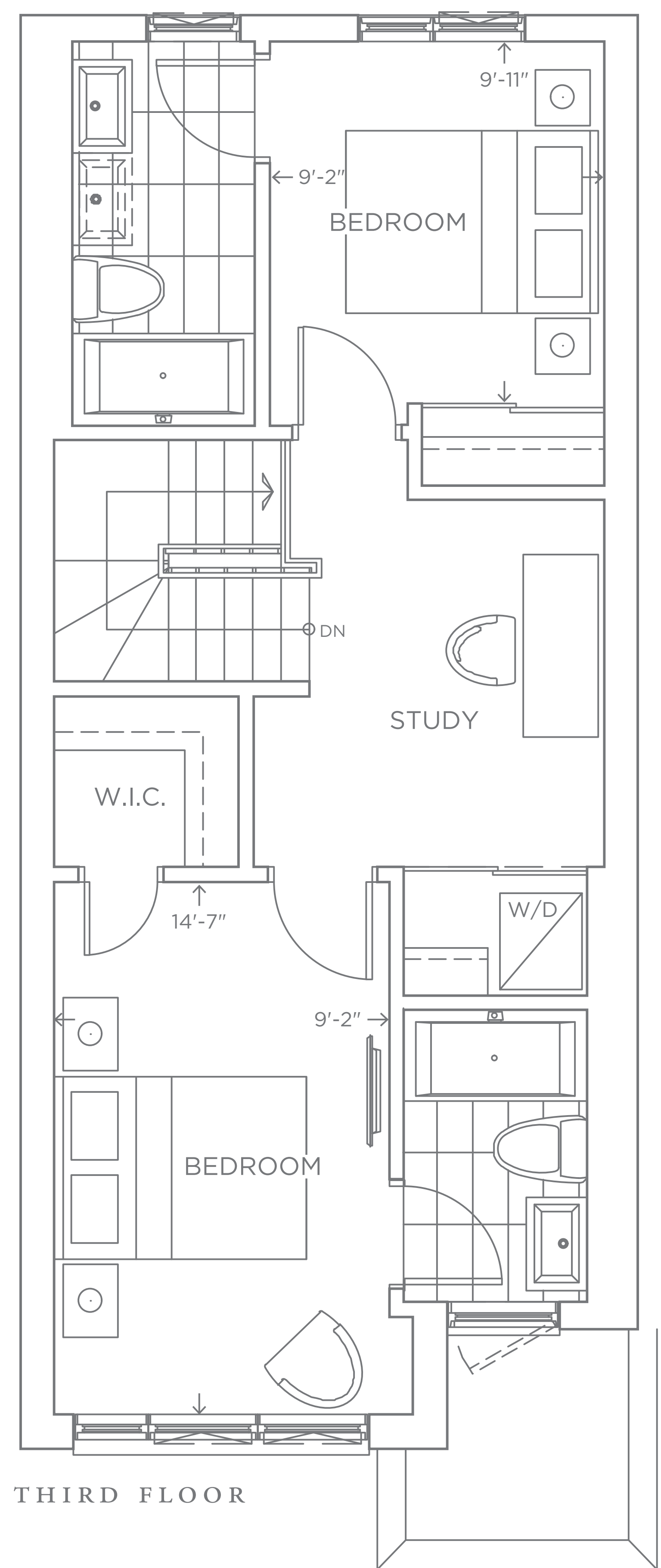
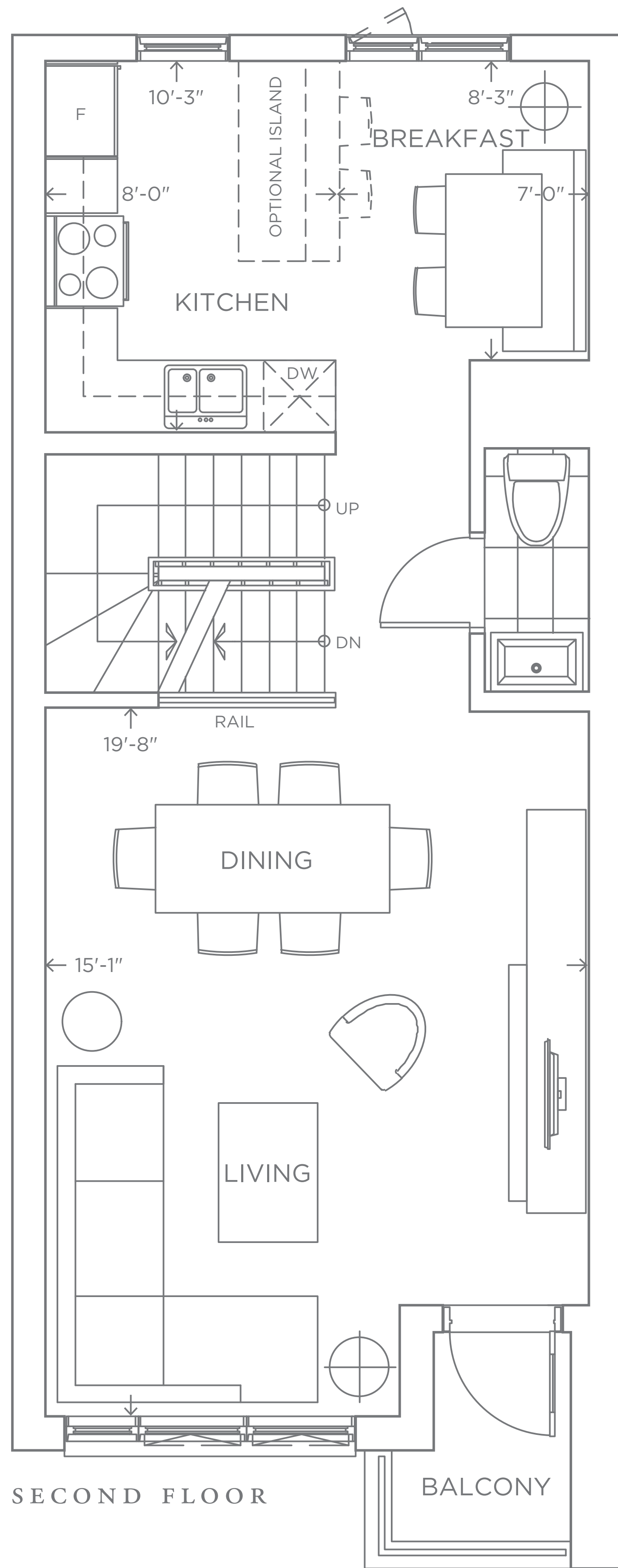

Exterior, windows, colours, grading, landscaping, garage and entrance doors may vary from the renderings. Furniture is displayed for illustration purposes only and does not necessarily reflect the electrical plan for the unit. Units are sold unfurnished. Materials, sizes and specifications are subject to change without notice. Orientation of suite may be reversed and purchaser agrees to accept same. Exterior colours, grading, landscaping, garage and entrance doors may vary from the renderings. All Schedule Y's attached to the legal agreement of purchase and sale supersede artist's renderings. The dimensions shown on this plan are approximate only. Actual useable floor space within the unit may vary from any stated floor areas or dimensions on this plan. For more information on the method used for calculating the floor area of any unit, reference should be made to Builder Bulletin No. 22 published by Tarion, E. & O.E. June 2020.

DOVE OI
2 BEDROOM

1323 SQ FT

1260 SQ FT
INTERIOR +
63 SQ FT
BALCONY

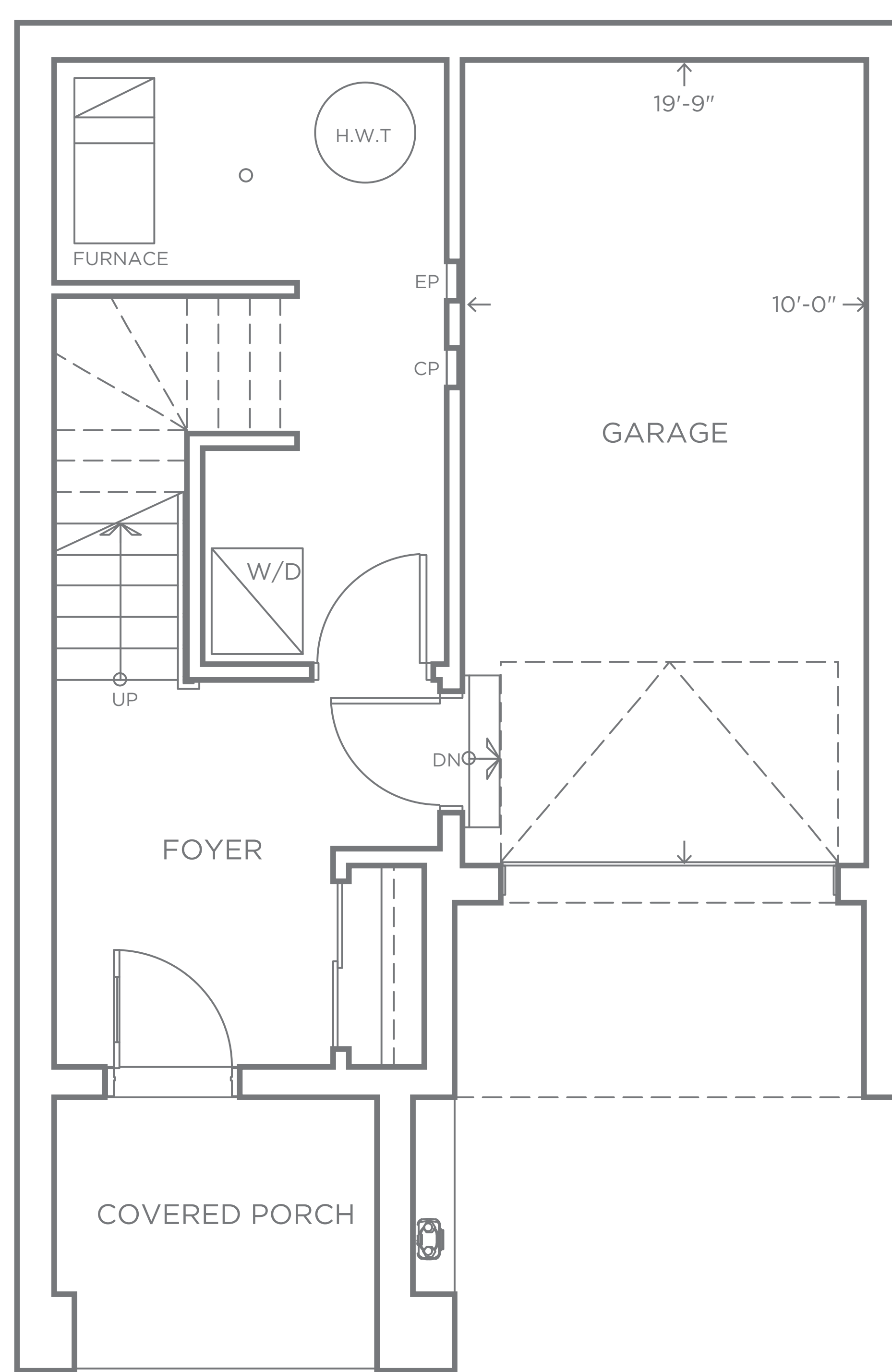
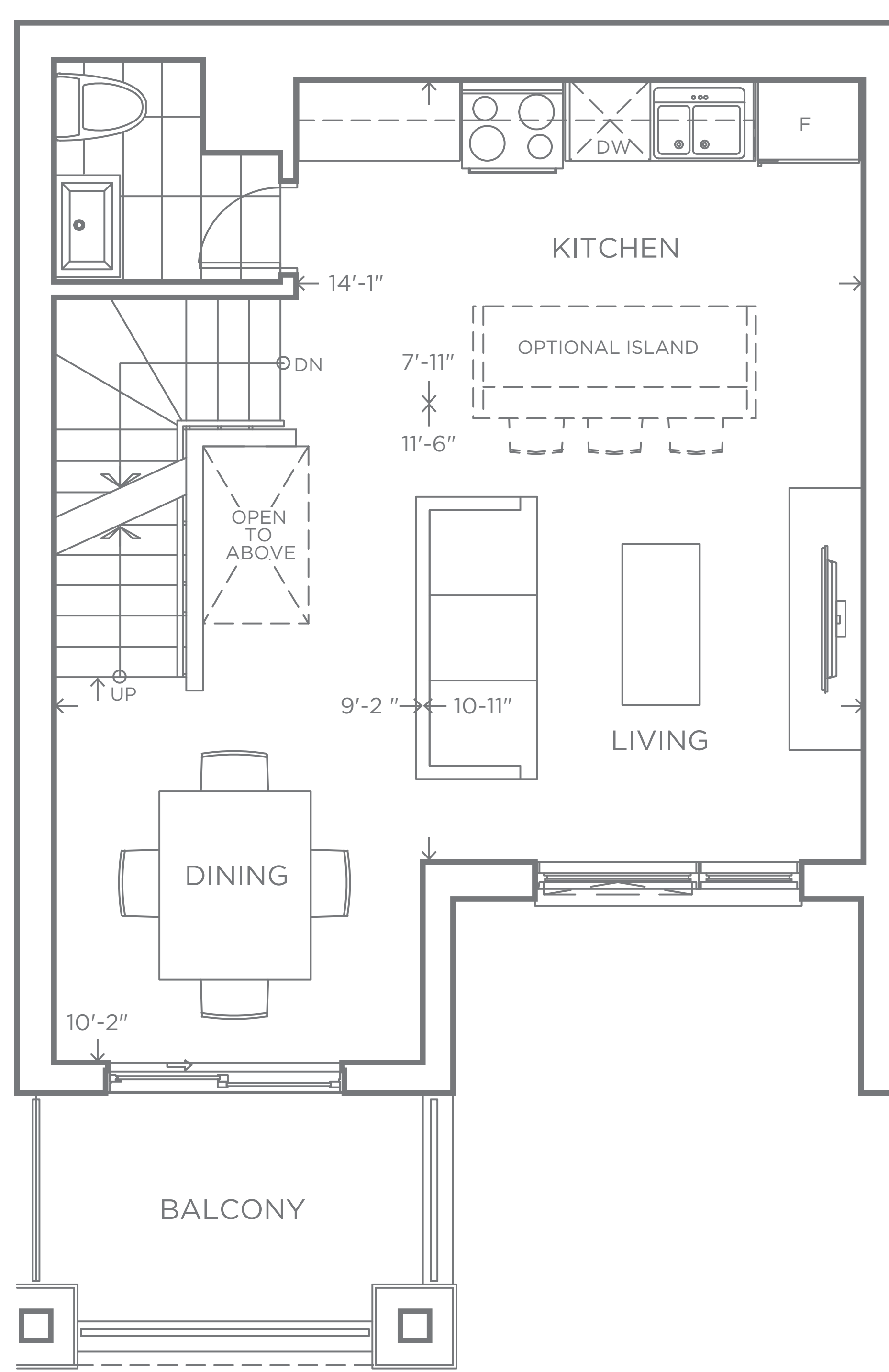
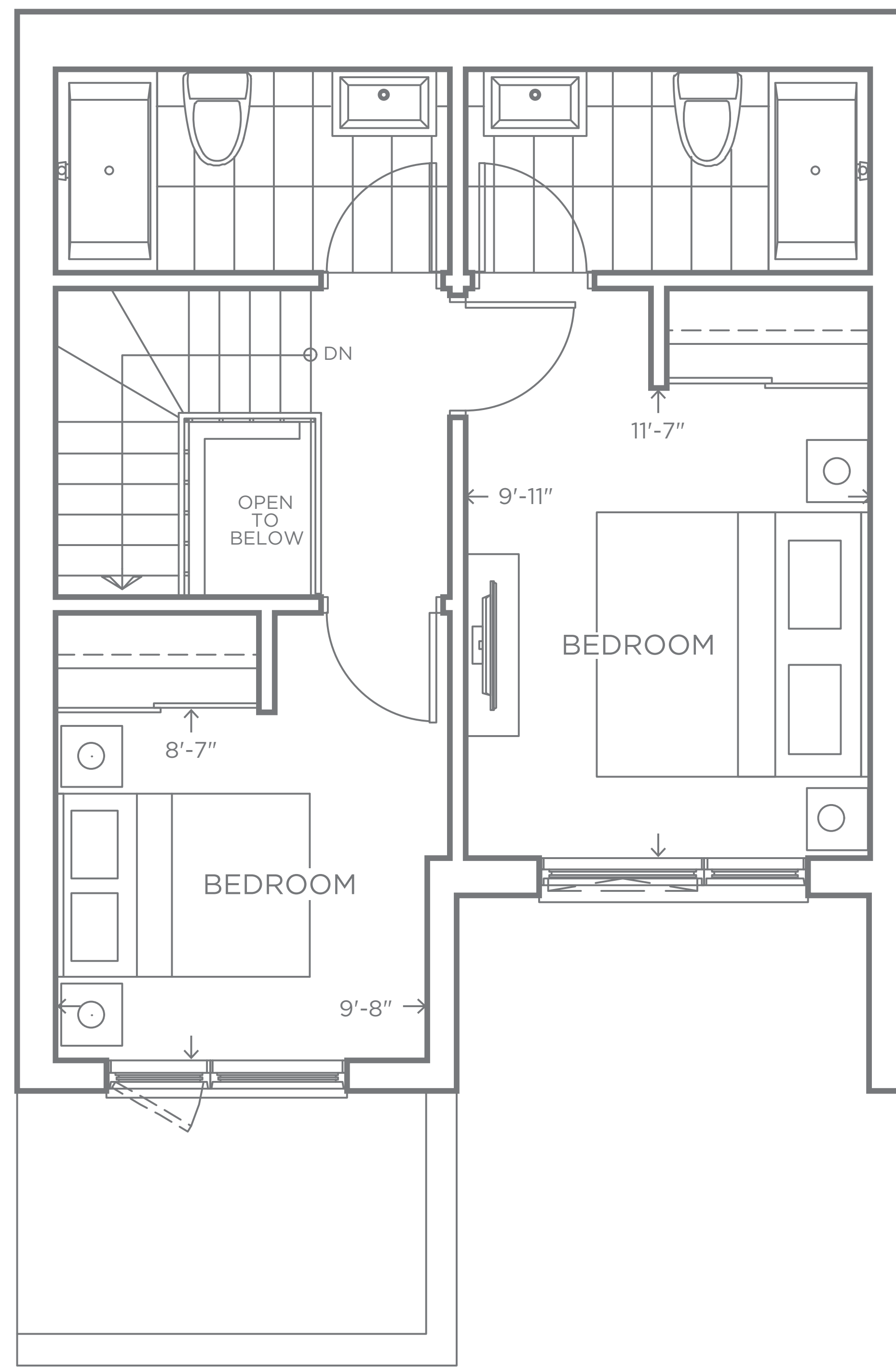

Exterior, windows, colours, grading, landscaping, garage and entrance doors may vary from the renderings. Furniture is displayed for illustration purposes only and does not necessarily reflect the electrical plan for the unit. Units are sold unfurnished. Materials, sizes and specifications are subject to change without notice. Orientation of suite may be reversed and purchaser agrees to accept same. Exterior colours, grading, landscaping, garage and entrance doors may vary from the renderings. All Schedule Y's attached to the legal agreement of purchase and sale supersede artist's renderings. The dimensions shown on this plan are approximate only. Actual useable floor space within the unit may vary from any stated floor areas or dimensions on this plan. For more information on the method used for calculating the floor area of any unit, reference should be made to Builder Bulletin No. 22 published by Tarion, E. & O.E. June 2020.

SPARROW 01
3 BEDROOM

1539 SQ FT

1473 SQ FT
INTERIOR +
66 SQ FT
BALCONY

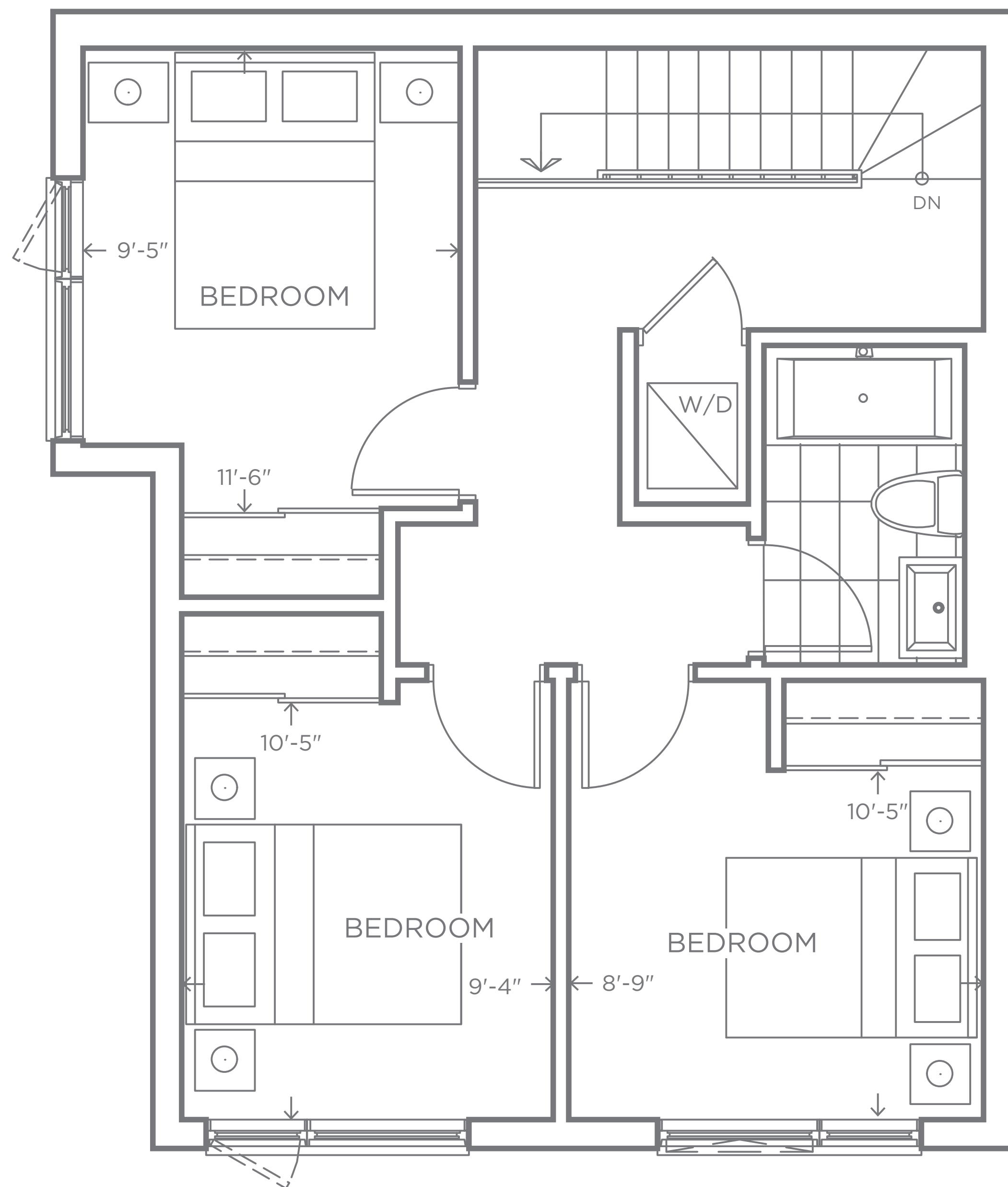

THIRD FLOOR

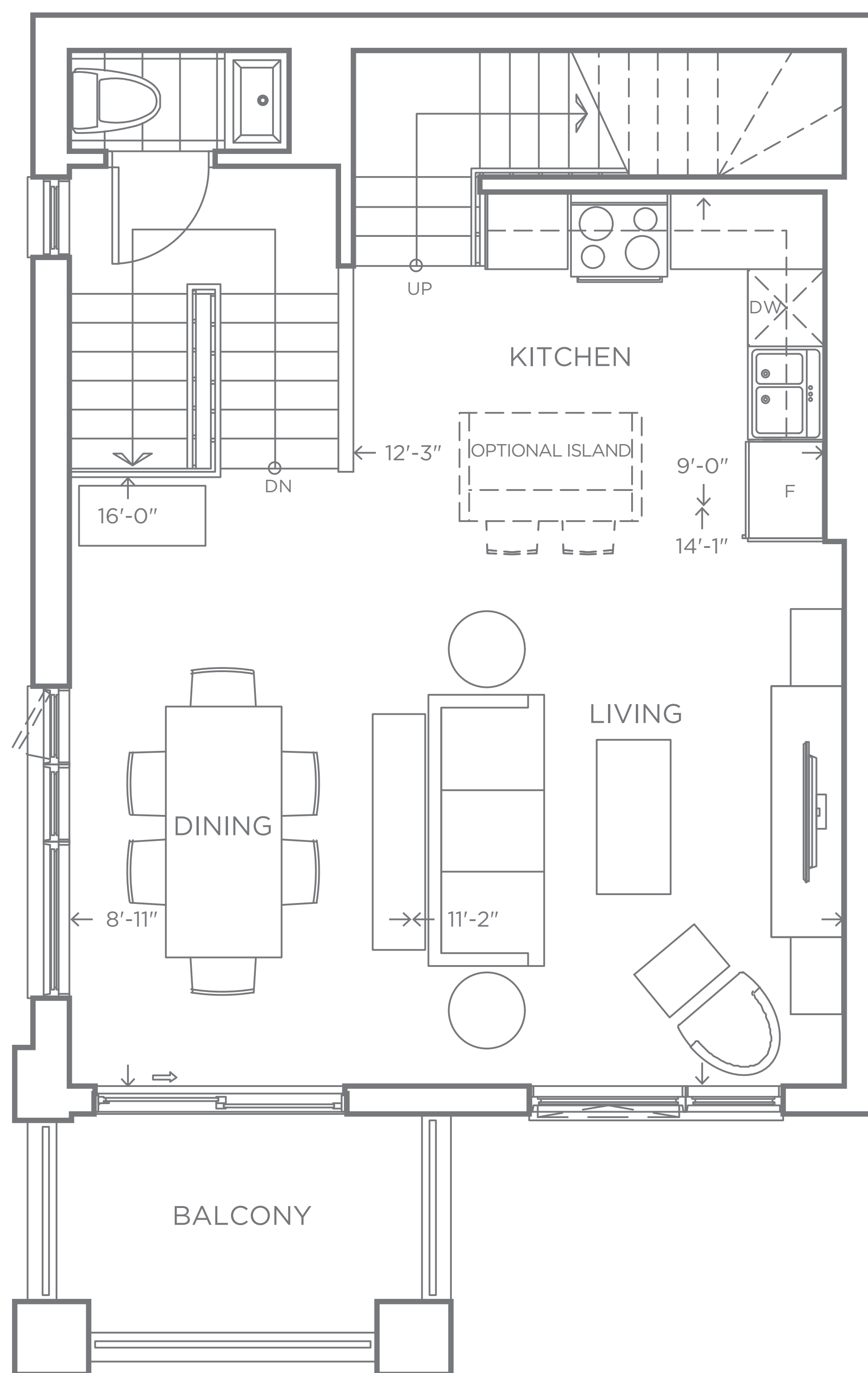

SECOND FLOOR

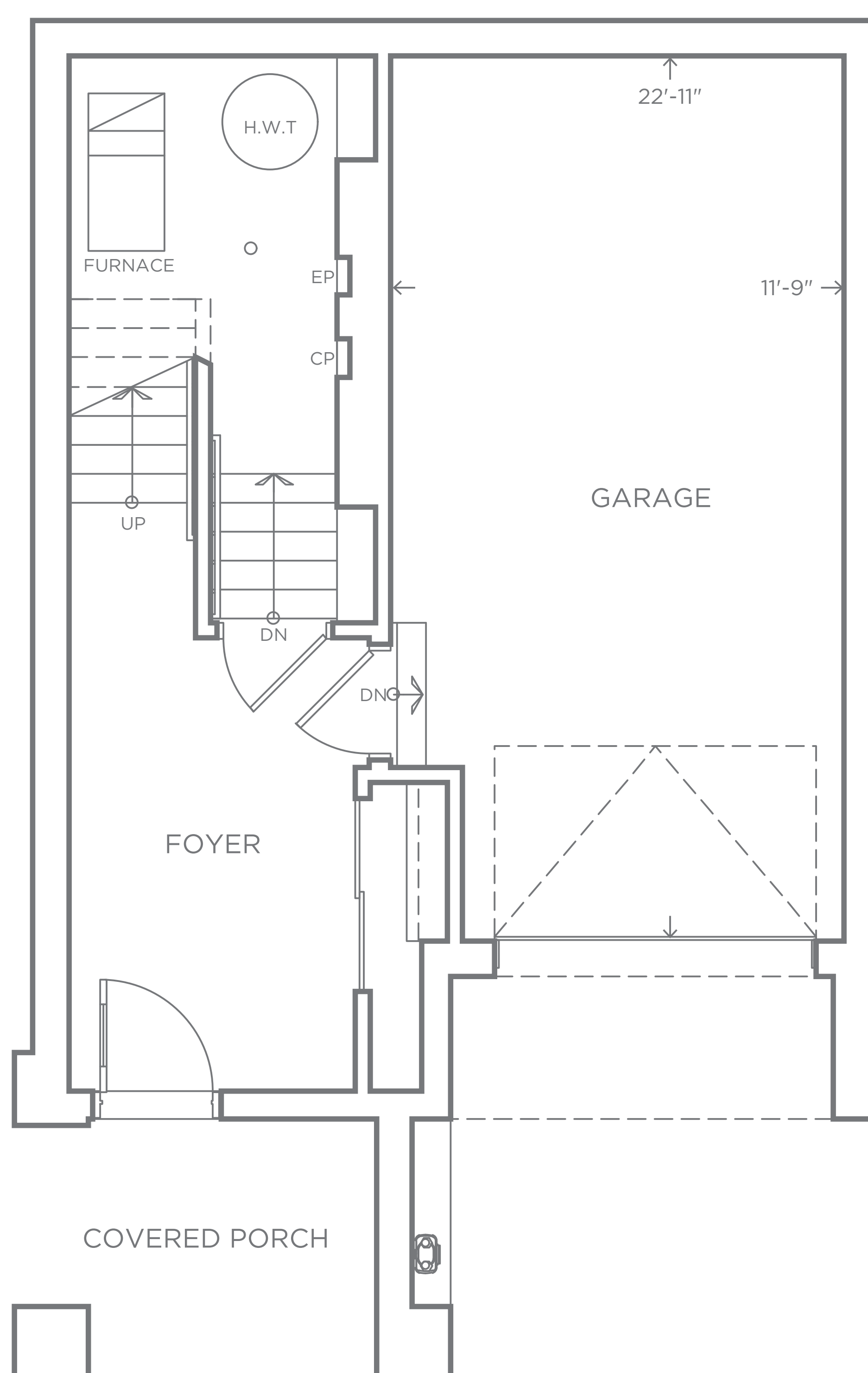

GROUND FLOOR

STARLING OI
3 BEDROOM

1527 SQ FT

1475 SQ FT
INTERIOR +
52 SQ FT
BALCONY

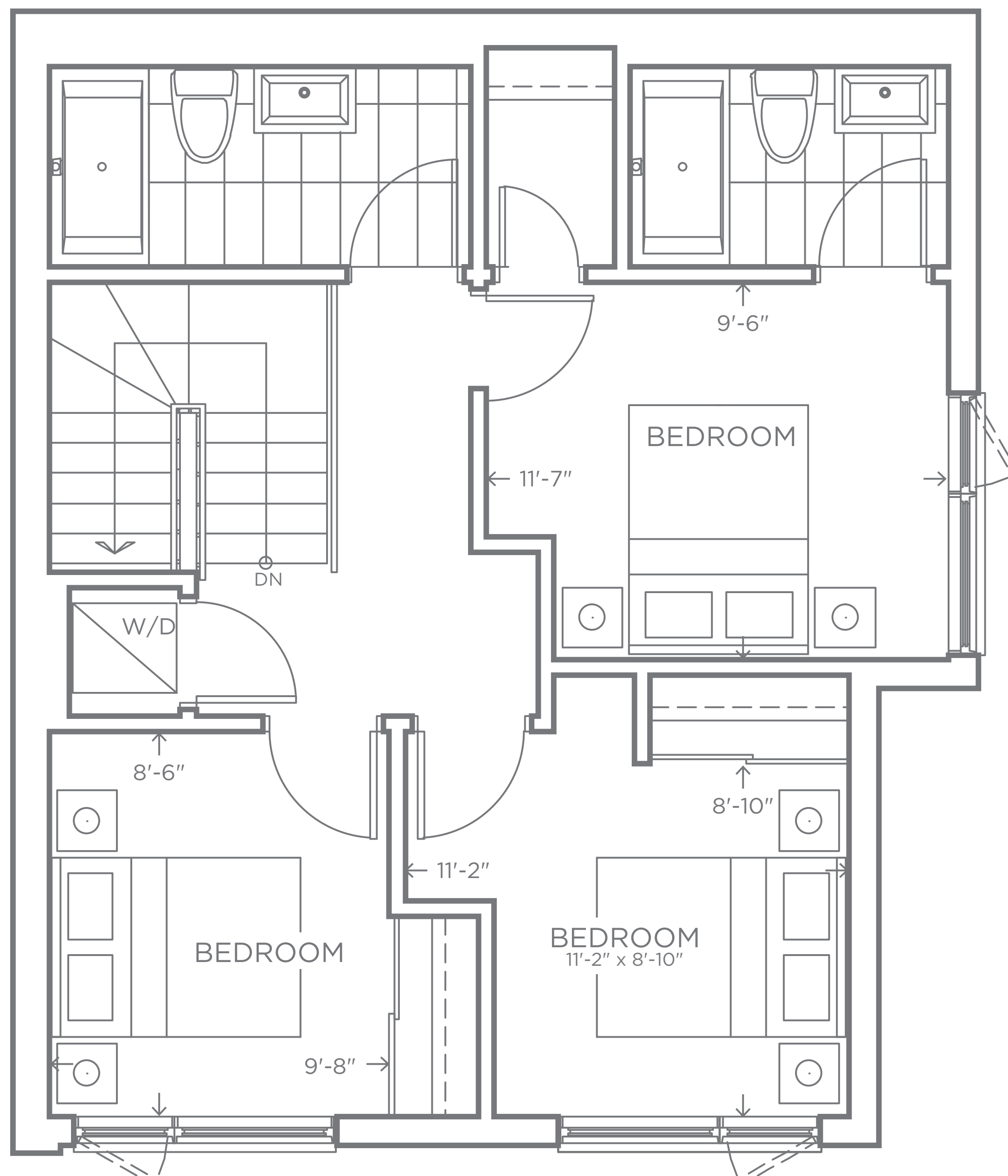

THIRD FLOOR

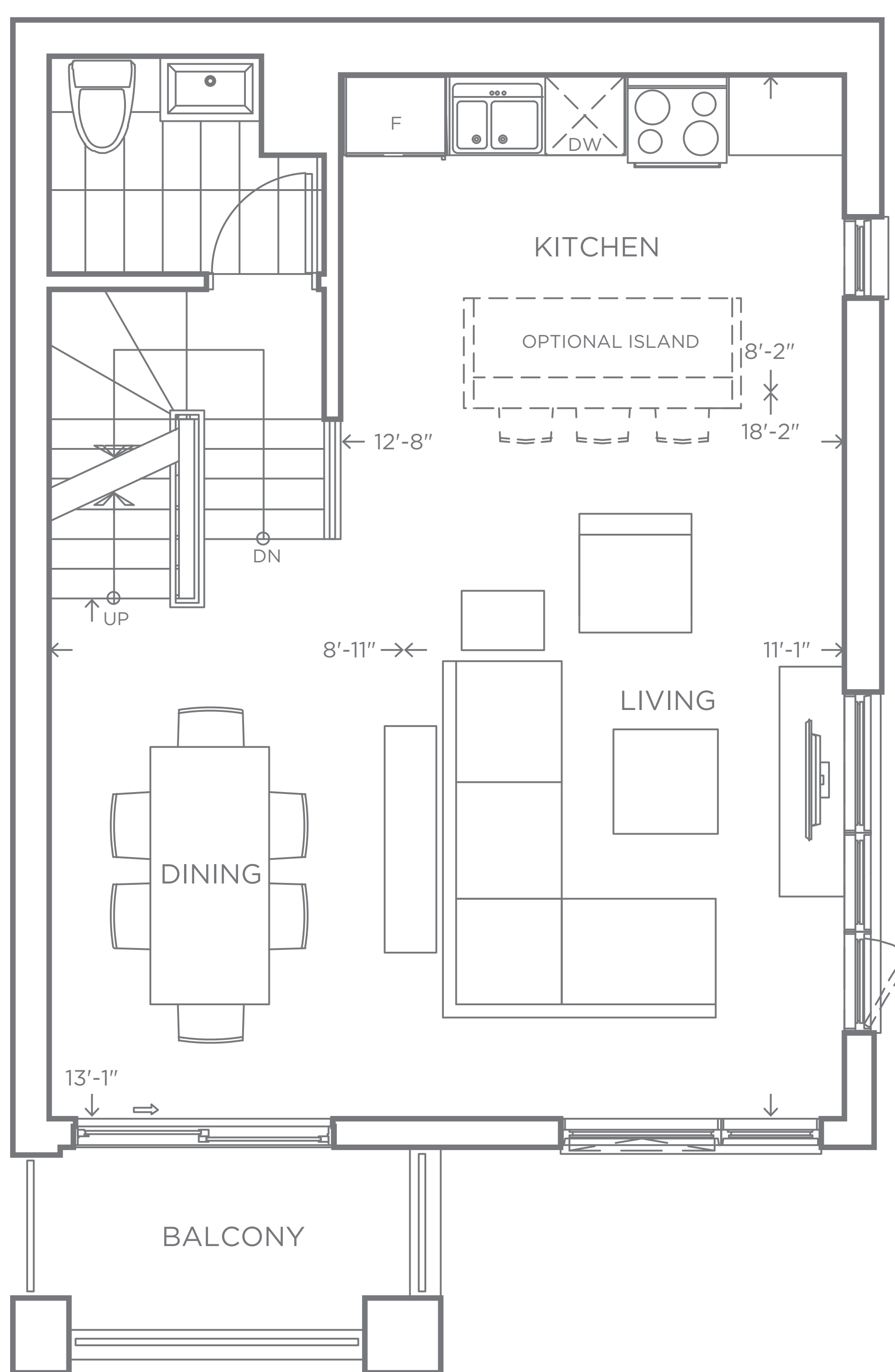

SECOND FLOOR

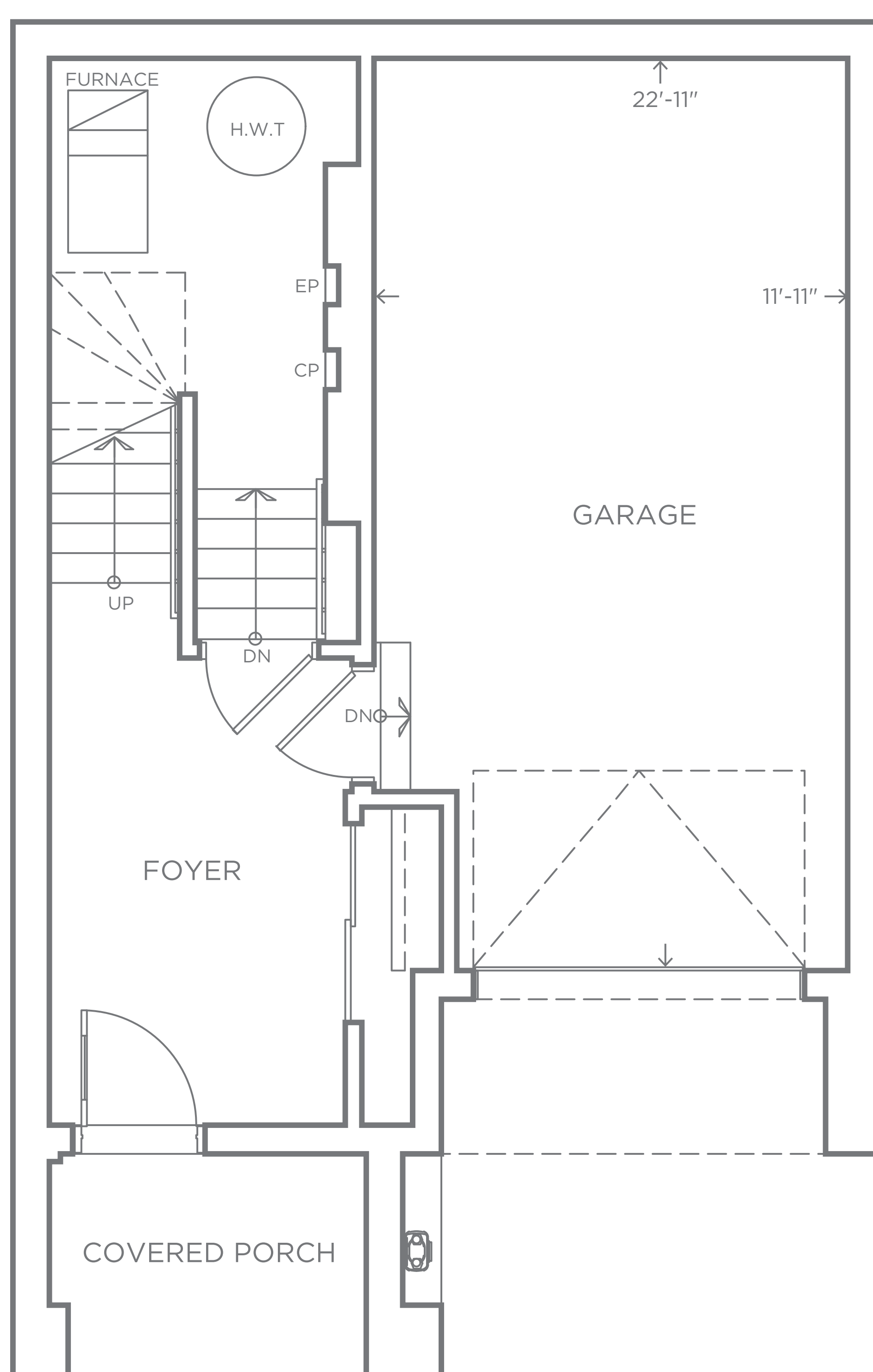

GROUND FLOOR

WREN OI
2 BEDROOM

1428 SQ FT

1374 SQ FT
INTERIOR +
54 SQ FT
BALCONY

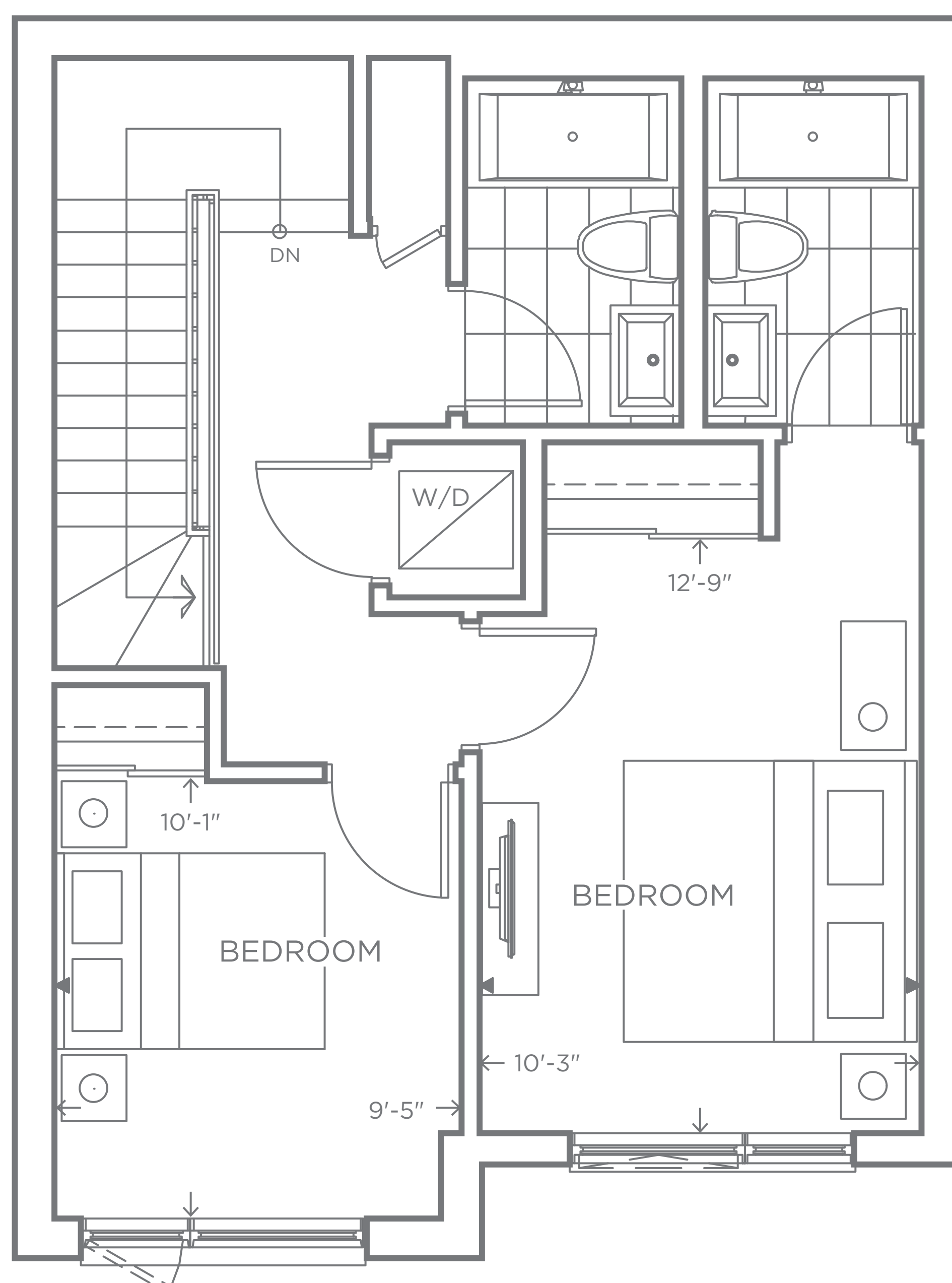

THIRD FLOOR

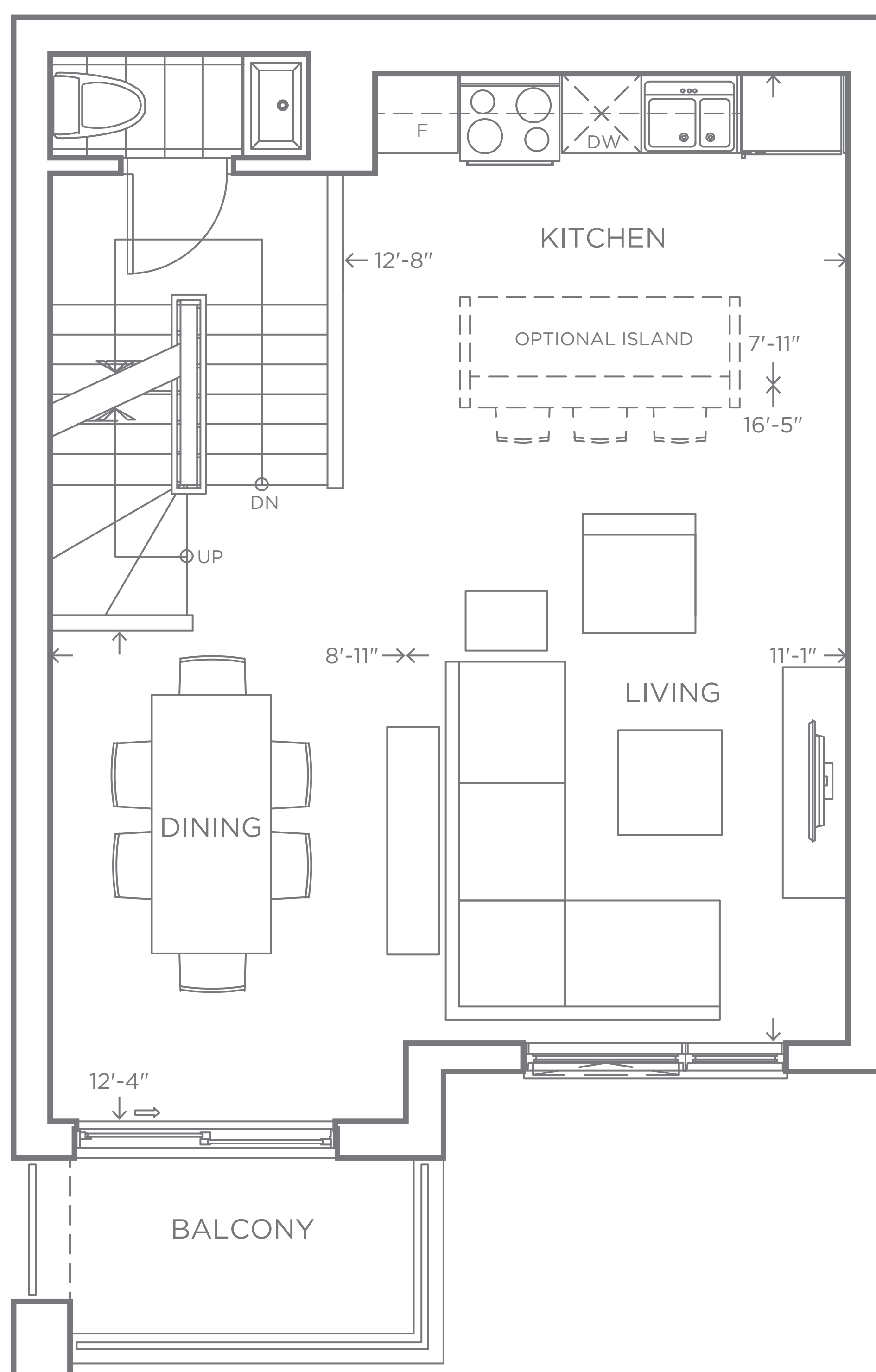

SECOND FLOOR

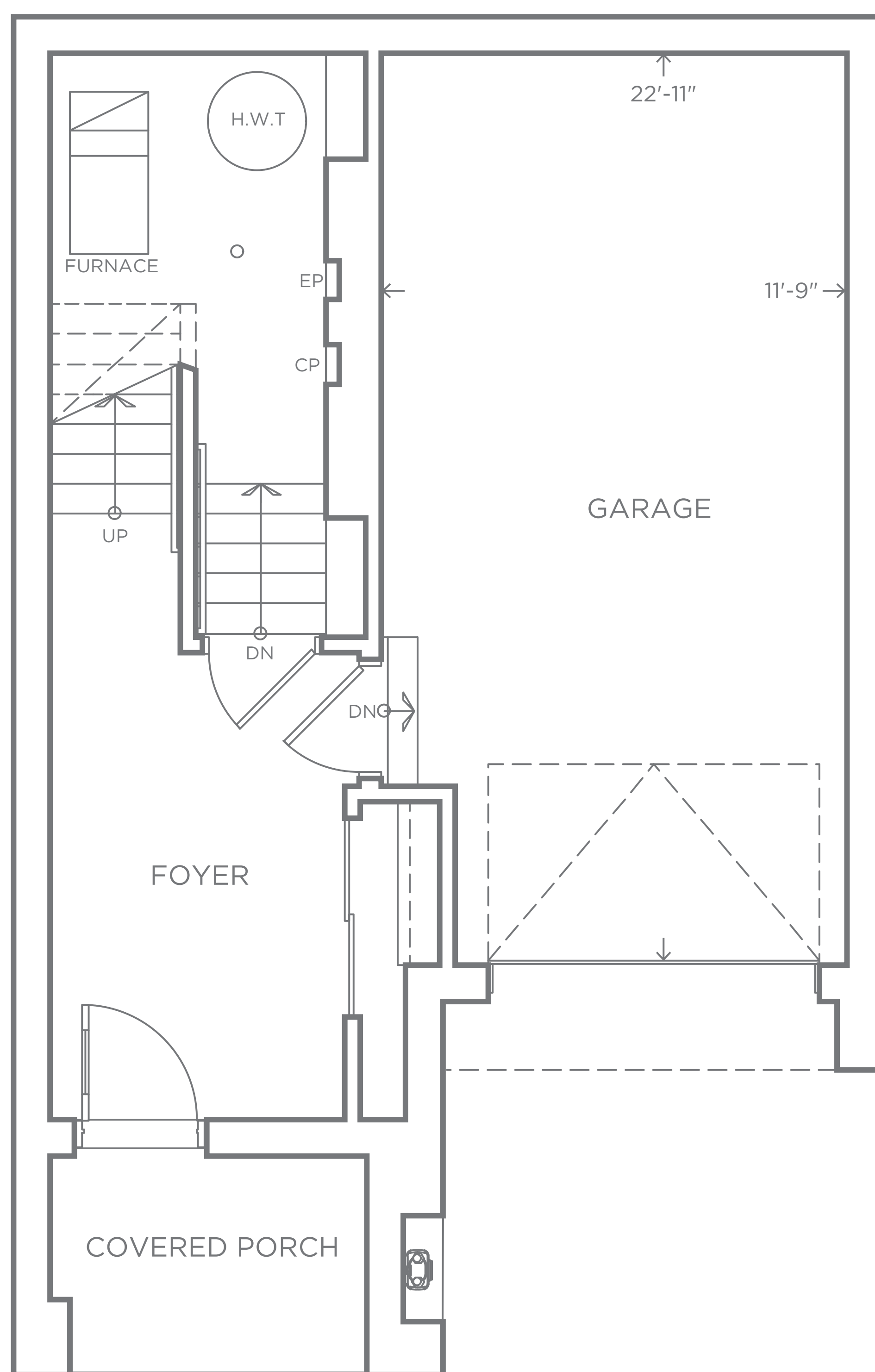

GROUND FLOOR

Exterior, windows, colours, grading, landscaping, garage and entrance doors may vary from the renderings. Furniture is displayed for illustration purposes only and does not necessarily reflect the electrical plan for the unit. Units are sold unfurnished. Materials, sizes and specifications are subject to change without notice. Orientation of suite may be reversed and purchaser agrees to accept same. Exterior colours, grading, landscaping, garage and entrance doors may vary from the renderings. All Schedule Ys attached to the legal agreement of purchase and sale supersede artist's renderings. The dimensions shown on this plan are approximate only. Actual useable floor space within the unit may vary from any stated floor areas or dimensions on this plan. For more information on the method used for calculating the floor area of any unit, reference should be made to Builder Bulletin No. 22 published by Tarion, E. & O.E. June 2020.

HERON 01
2 BEDROOM

1394 SQ FT

1322 SQ FT
INTERIOR +
72 SQ FT
BALCONY

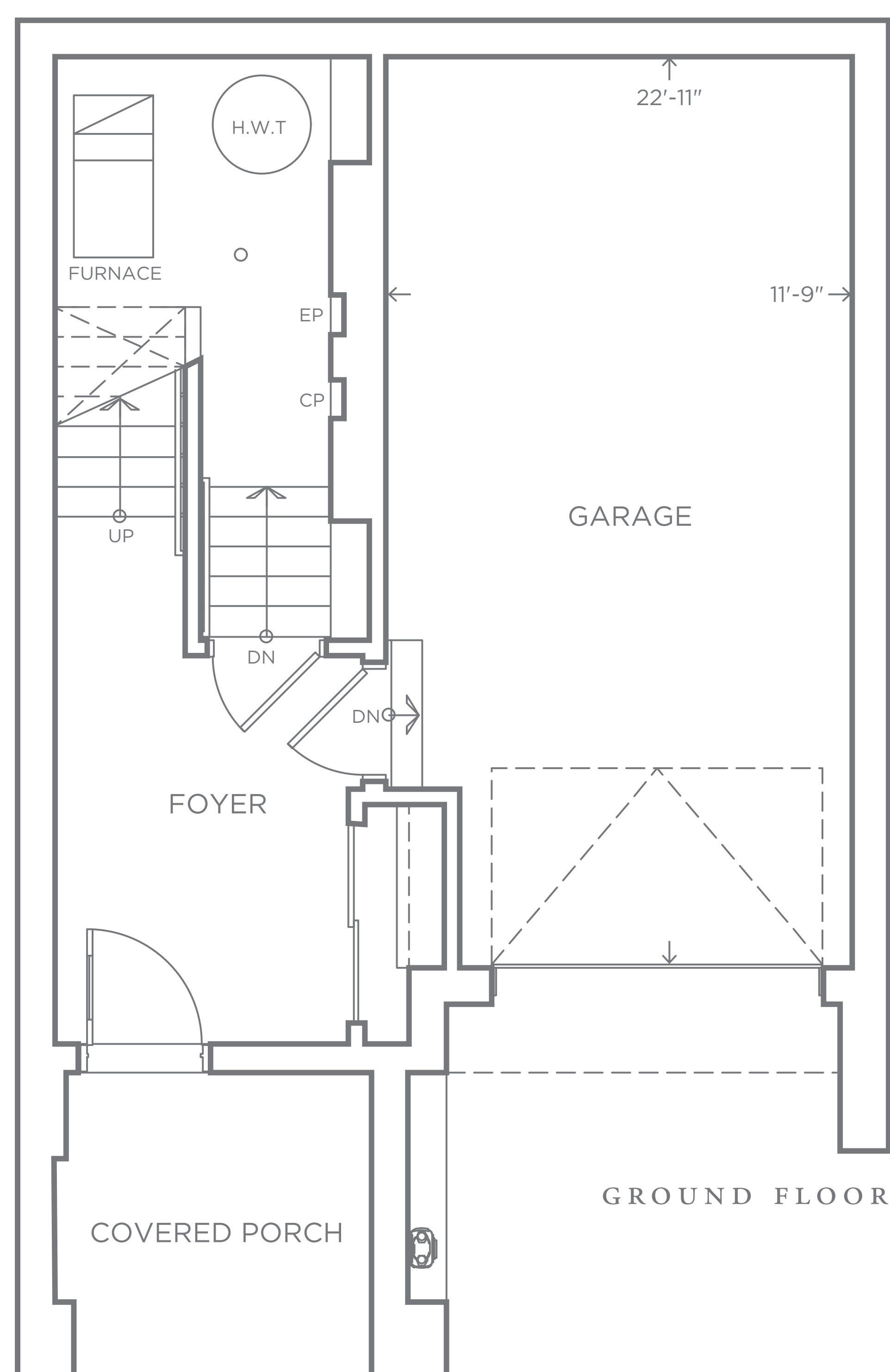
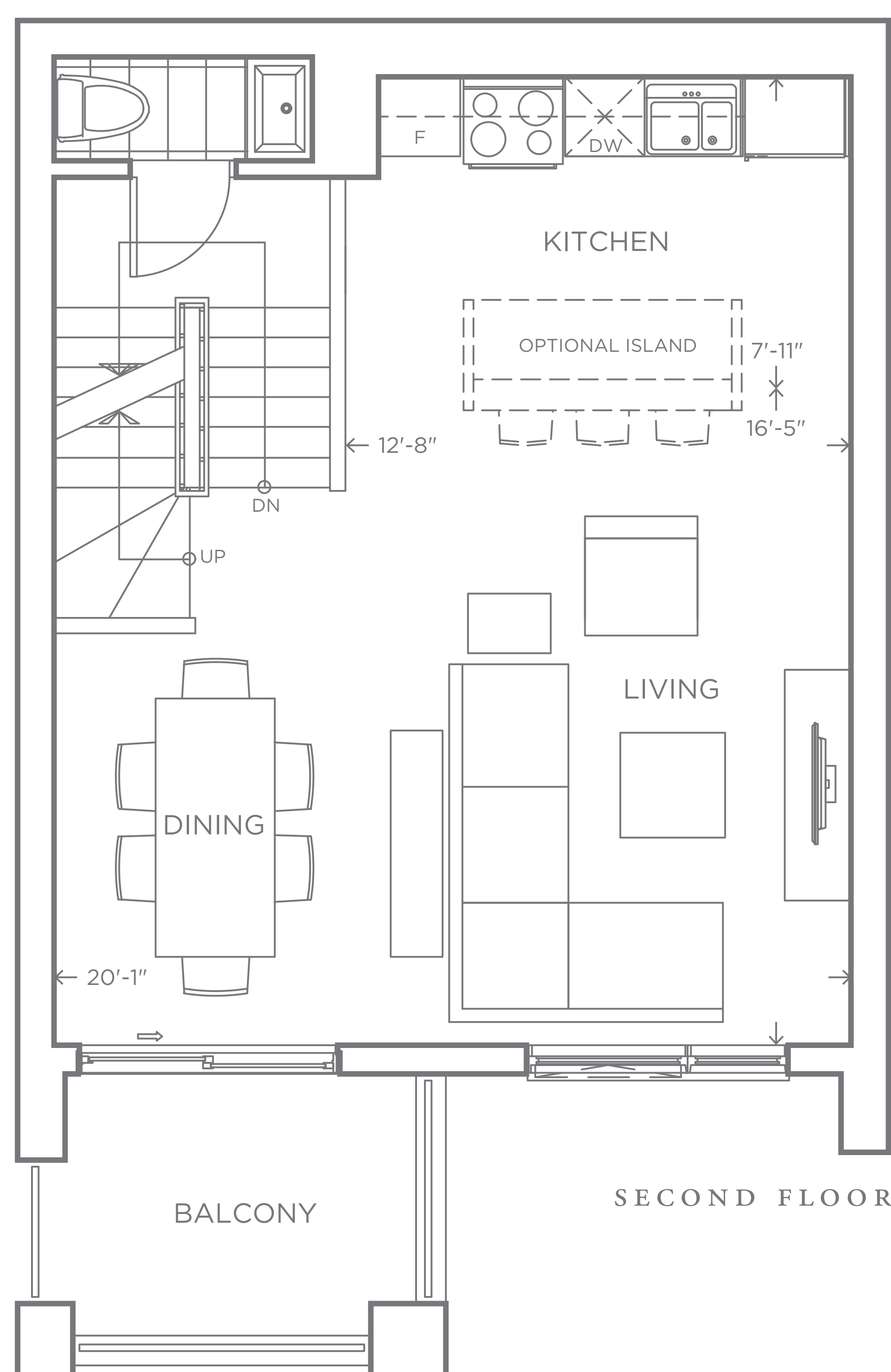
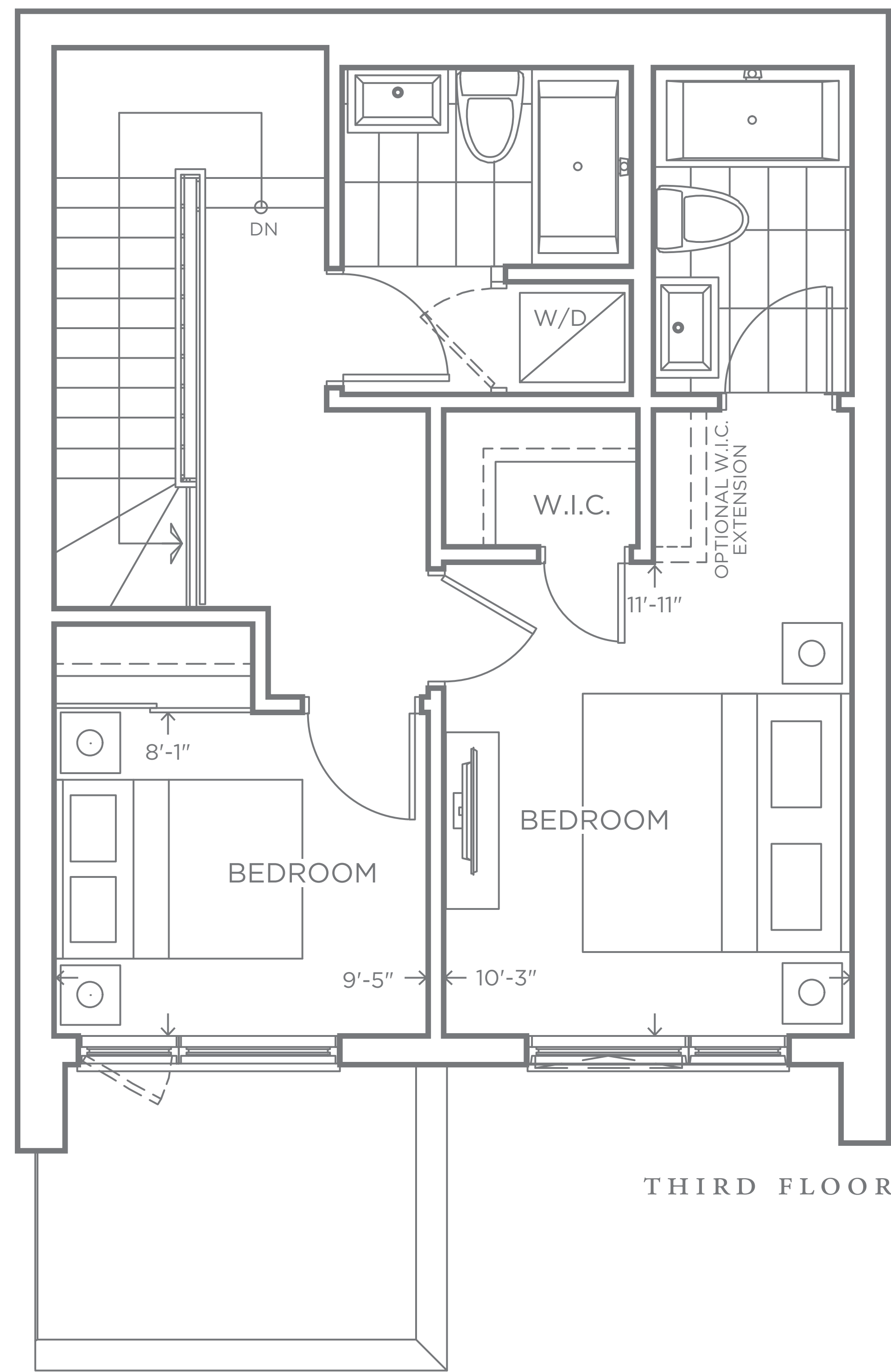

Exterior, windows, colours, grading, landscaping, garage and entrance doors may vary from the renderings. Furniture is displayed for illustration purposes only and does not necessarily reflect the electrical plan for the unit. Units are sold unfurnished. Materials, sizes and specifications are subject to change without notice. Orientation of suite may be reversed and purchaser agrees to accept same. Exterior colours, grading, landscaping, garage and entrance doors may vary from the renderings. All Schedule Ys attached to the legal agreement of purchase and sale supersede artist's renderings. The dimensions shown on this plan are approximate only. Actual useable floor space within the unit may vary from any stated floor areas or dimensions on this plan. For more information on the method used for calculating the floor area of any unit, reference should be made to Builder Bulletin No. 22 published by Tarion, E. & O.E. June 2020.